



ORIGINAL INSTRUCTIONS

Instruction Manual

High Vacuum Angle Valve

Electromagnetic / Bellows Pressure Balance Type

XLS-Q Series

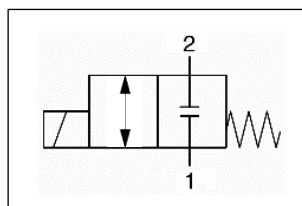

The intended use of this product is to isolate between a vacuum pump and chamber.

1 Safety Instructions

These safety instructions are intended to prevent hazardous situations and/or equipment damage. These instructions indicate the level of potential hazard with the labels of "Caution," "Warning" or "Danger." They are all important notes for safety and must be followed in addition to International Standards (ISO/IEC^{*)}, and other safety regulations.

- ^{*)} ISO 4414: Pneumatic fluid power - General rules relating to systems.
- ISO 4413: Hydraulic fluid power - General rules relating to systems.
- IEC 60204-1: Safety of machinery - Electrical equipment of machines. (Part 1: General requirements)
- ISO 10218-1: Robots and robotic devices - Safety requirements for industrial robots - Part 1: Robots.

- Refer to product catalogue, Operation Manual and Handling Precautions for SMC Products for additional information.
- Keep this manual in a safe place for future reference.

Caution	Caution indicates a hazard with a low level of risk which, if not avoided, could result in minor or moderate injury.
Warning	Warning indicates a hazard with a medium level of risk which, if not avoided, could result in death or serious injury.
Danger	Danger indicates a hazard with a high level of risk which, if not avoided, will result in death or serious injury.

Warning

- Always ensure compliance with relevant safety laws and standards.
- All work must be carried out in a safe manner by a qualified person in compliance with applicable national regulations.

2 Specifications

2.1 General specifications

Model	XLS-16	XLS-25
Valve type	Normally closed (N.C.)	
Fluid	Inert gas under vacuum	
Fluid and ambient temperature range [°C]	5 to 40	
Operating pressure [Pa](abs)	0.1 [MPa](G) to 1x10 ⁻⁶	
Conductance [L/s] ^{Note 1)}	5	8
Body material	Aluminium alloy	
Seal material	FKM	
Other material in contact with fluid ^{Note 2)}	Stainless steel SUS316L / SUS304, SUS405 equivalent, PFA	
Flange size	KF16	KF25
Leakage [Pa m ³ /s]	Internal	1.3 x 10 ⁻⁸ at ordinary temperatures - excluding gas permeation
	External	1.3 x 10 ⁻¹¹ at ordinary temperatures - excluding gas permeation
Weight [kg]	0.4	0.7

Table 1.

Note 1) Conductance is the value for the elbow with the same dimensions.
 Note 2) A coating of vacuum grease [Y-VAC3] is applied to the valve seat of the vacuum part.

2 Specification – continued

2.2 Coil specifications

Model	XLS-16	XLS-25
Control Power Supply	No	
Operating voltage [V]	24/6, 48/12, 100/24 VDC	
Allowable voltage fluctuation [%]	±10	
Electrical entry type	G, C, D, T	
Lead wire	AWG20, O.D. 2.63mm	
Coil insulation	Class B	
Max. operating frequency [Hz]	0.17	

Table 2.

Warning

Special products (-X) might have specifications different from those shown in this section. Contact SMC for specific drawings.

3 Installation

3.1 Installation

Warning

- Do not install the product unless the safety instructions have been read and understood.
- Use clean air. Do not use air that contains chemicals, synthetic oils that include organic solvents, salt, corrosive gases, etc., as it can cause damage or malfunction.
- Install an air filter if necessary close to the valve on the upstream side.
- Use within stated ambient temperature range. Check the compatibility of product's materials with any fluid contained in the ambient atmosphere. Ensure that any harmful fluid used does come into contact with the external surface of the product.
- Take measures to prevent static electricity since some fluids can cause

static electricity.

- Not suitable for use as an emergency shutoff valve. These valves are not designed for safety applications such as an emergency shutoff valve. If the valves are used for the mentioned applications, additional safety measures should be adopted.
- Be aware that the valve surface may get hot if operated continuously. The solenoid coil will generate heat when continuously energized, so avoid installing it in an enclosed space.
- Do not touch the coil while it is being energized or immediately after energization.

3.2 Vacuum Piping

Warning

- Before piping make sure to clean up chips, cutting oil, dust etc. Clean the surface of the flange seal and the O-ring with ethanol, etc.
- Be sure that the flange O-ring is compressed by 15% or more.
- In high humidity environments, keep in packaged condition until just before piping.
- Seal part on flange is protected, but for safety reasons, do not handle.
- Perform piping so that excessive force is not applied to the flange sections. In case there is vibration of heavy objects or attachments, secure them so that torque is not applied directly to the flanges.

3.3 Leakage voltage

Caution

Particularly when using a resistor in parallel with a switching element and when using a C-R element (surge voltage suppressor) to protect the switching element, take note that leakage current will flow through the resistor, C-R element, etc., which may prevent the valve from turning off. Suppressor residual voltage leakage should be as follows:

3 Installation - continued

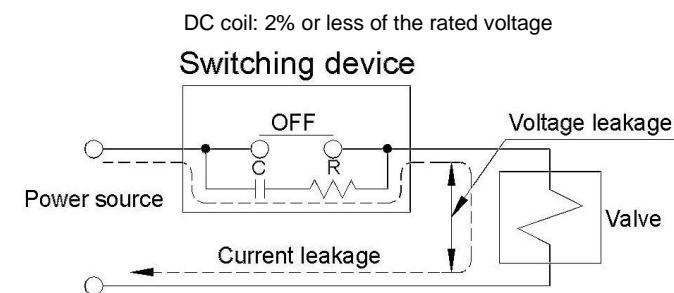

Figure 1.

3.4 Valve mounting

Warning

- Not following proper maintenance procedures could cause the product to malfunction and lead to equipment damage.
- If leakage increases or equipment does not operate properly, stop operation.
- After mounting is complete, confirm that it was done correctly by performing a suitable function test.
- Do not warm the coil assembly with a heat insulator, etc. Use tape, heaters, etc., for freeze prevention on the piping and the body only. The coil can cause it to burn out.
- Avoid sources of vibration or adjust the arm from the body to the minimum length so that resonance will not occur.
- Warnings or specifications printed or labelled on the product should not be erased, removed, or covered up.

3.5 Environment

Warning

- Do not use in an environment where corrosive gases, chemicals, salt water or steam are present.
- Do not use in an explosive atmosphere.

- Do not expose to direct sunlight. Use a suitable protective cover.
- Do not install in a location subject to vibration or impact in excess of the product's specifications.
- Do not mount in a location exposed to radiant heat that would result in temperatures in excess of the product's specifications.

3.6 Lubrication

Caution

- SMC products have been lubricated for life at manufacture, and do not require lubrication in service.
- If a lubricant is used in the system, refer to catalogue for details.

3.7 Wiring

Caution

- When DC power is connected to a solenoid valve equipped with light and/or surge voltage suppressor, check for polarity indications.
- Avoid incorrect wiring, as this can cause malfunction and damage the product.
- To prevent noise and surge in signal lines, keep all wiring separate from power lines and high voltage lines. Otherwise, this can cause malfunction.
- When a surge from the solenoid affects the electrical circuitry, install a surge absorber, etc., in parallel with the solenoid. Or use an option that comes with surge voltage protection circuit. However, a surge voltage occurs even if the surge voltage protection circuit is used. For details, please consult with SMC.
- Use electrical circuits that do not generate chattering in their contacts.
- Use voltages that are within ±10% of the rated voltage. In cases with a DC power supply where responsiveness is important, stay within ±5% of the rated value (there will be a voltage drop in the lead wires connecting to the coil).
- As a rule, use electrical wire with cross sectional area 0.5 to 1.25 mm² for wiring.

3 Installation - continued

- Do not bend or pull cables repeatedly.
- Connect the wires so that an external force greater than 10 N is not applied to the lead wire, otherwise the coil will burn.

3.8 Electrical connections

3.8.1 Grommet

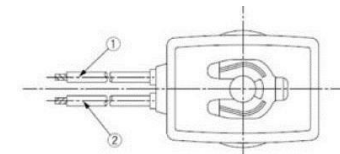

Figure 2.

Voltage	Lead wire colour	
	1	2
DC	Black	Red

Note) There is no polarity

Table 3.

3.8.2 DIN Terminal

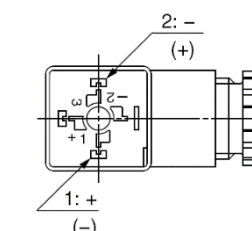

Figure 3.

Terminal no.	1	2
DIN Terminal	+(-)	-(+)

Note) There is no polarity

Table 4.

- Use a heavy-duty cord with an outside cable diameter of Ø6 to 12 mm.
- Tighten screws and fittings according to Figure 4.

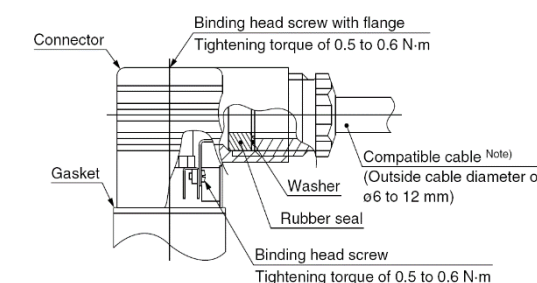
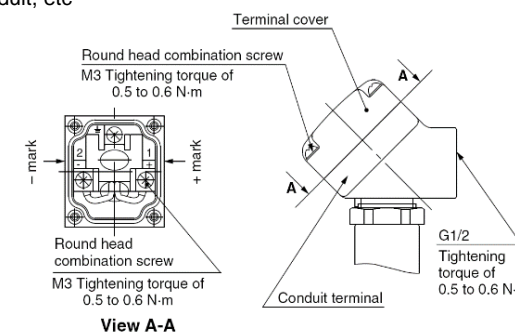

Figure 4.

Note) For cables with an O.D. of Ø9 to Ø12 mm, remove the internal parts of the rubber seal before using.

3.8.3 Conduit Terminal

- Make connections according to the marking shown in Figure 5.
- Tighten screws and fittings according to Figure 5.
- Properly seal the terminal connection (G1/2) with special wiring conduit, etc



View A-A (Internal connection diagram)

Figure 5.

3 Installation - continued

3.8.4 Conduit

- When used as an IP65 equivalent use seal (part number VCW20-15-6 ordered separately) to install the wiring conduit.
- Tighten conduit to torque shown in Figure 6.

Class B coil: AWG20 Outside insulator diameter of 2.5 mm

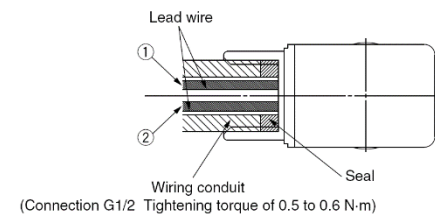

Figure 6.

Rated Voltage	Lead wire colour	
	1	2
DC	Black	Red

Note) There is no polarity.

Table 5.

Description	Part no.
Seal	VCW20-15-6

Note) Please order separately.

Table 6.

3.9 Electrical circuits

- DC circuit

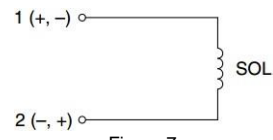

Figure 7.

4 How to Order

Refer to drawings for 'How to Order'.

5 Outline Dimensions

Refer to drawings for outline dimensions.

6 Maintenance

6.1 General maintenance

Caution

- Not following proper maintenance procedures could cause the product to malfunction and lead to equipment damage.
- If handled improperly, compressed air can be dangerous.
- Maintenance of pneumatic systems should be performed only by qualified personnel.
- Before performing maintenance, turn off the power supply and be sure to cut off the supply pressure. Confirm that the air is released to atmosphere.
- After installation and maintenance, apply operating pressure and power to the equipment and perform appropriate functional and leakage tests to make sure the equipment is installed correctly.
- If any electrical connections are disturbed during maintenance, ensure they are reconnected correctly, and safety checks are carried out as required to ensure continued compliance with applicable national regulations.
- Do not make any modification to the product.
- Do not disassemble the product, unless required by installation or maintenance instructions.

7 Limitations of Use

7.1 Limited warranty and disclaimer/compliance requirements

Refer to Handling Precautions for SMC Products.

Caution

7.2 Voltage

- The starting voltage should be applied for only 0.15 to 0.20s, in accordance with described method (indicated on the back of the coil.) Continuously applying the starting voltage will damage the coil, cause it to overheat and could possibly cause a fire. The holding voltage is 25% of the starting voltage (the application method is shown on the back of the solenoid coil.)

Without electrical option

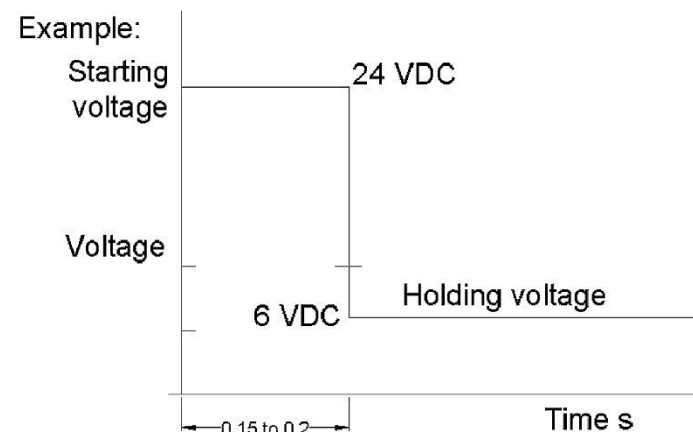

Figure 8.

8 Product Disposal

This product shall not be disposed of as municipal waste. Check your local regulations and guidelines to dispose this product correctly, in order to reduce the impact on human health and the environment.

9 Contacts

Refer to www.smcworld.com or www.smc.eu for your local distributor/importer.

SMC Corporation

URL : <https://www.smcworld.com> (Global) <https://www.smc.eu> (Europe)
 SMC Corporation, 4-14-1, Sotokanda, Chiyoda-ku, Tokyo 101-0021, Japan
 Specifications are subject to change without prior notice from the manufacturer.
 © 2022 SMC Corporation All Rights Reserved.
 Template DKP50047-F-085M