



Instruction Manual Pressure Sensor Controller PSE30# / PSE31# series



The intended use of the pressure sensor controller is to monitor and display pressure information from a pressure sensor.

1 Safety Instructions

These safety instructions are intended to prevent hazardous situations and/or equipment damage. These instructions indicate the level of potential hazard with the labels of "Caution," "Warning" or "Danger." They are all important notes for safety and must be followed in addition to International Standards (ISO/IEC^{*)}, and other safety regulations.

^{*)} ISO 4414: Pneumatic fluid power - General rules relating to systems.
ISO 4413: Hydraulic fluid power - General rules relating to systems.
IEC 60204-1: Safety of machinery - Electrical equipment of machines. (Part 1: General requirements)
ISO 10218-1: Manipulating industrial robots - Safety, etc.

- Refer to product catalogue, Operation Manual and Handling Precautions for SMC Products for additional information.
- Keep this manual in a safe place for future reference.

	Caution	Caution indicates a hazard with a low level of risk which, if not avoided, could result in minor or moderate injury.
	Warning	Warning indicates a hazard with a medium level of risk which, if not avoided, could result in death or serious injury.
	Danger	Danger indicates a hazard with a high level of risk which, if not avoided, will result in death or serious injury.

Warning

- Always ensure compliance with relevant safety laws and standards.**
- All work must be carried out in a safe manner by a qualified person in compliance with applicable national regulations.
- This product is class A equipment intended for use in an industrial environment. There may be potential difficulties in ensuring electromagnetic compatibility in other environments due to conducted or radiated disturbances.
- Refer to the operation manual on the SMC website (URL: <https://www.smcworld.com>) for more safety instructions.

2 Specifications

2.1 General specifications

Model No.	PSE3##					
	Compound Pressure	Vacuum	Low Pressure	Positive Pressure	Low Differential	
Rated pressure range	-100 to 100 kPa	0 to -101 kPa	0 to 100 kPa	0 to 1 MPa	0 to 500 kPa	0 to 2 kPa
Set pressure range	-101 to 101 kPa	10 to -101 kPa	-10 to 100 kPa	-0.1 to 1 MPa	-50 to 500 kPa	-0.2 to 2 kPa
Set pressure resolution	0.2 kPa	0.1 kPa	0.1 kPa	0.001 MPa	1 kPa	0.01 kPa
Power supply voltage	12 to 24 VDC, ripple (p-p) 10% or less (protected against reverse connection)					
Current consumption	50 mA or less (no load)					
Sensor input signal	PSE30#: Voltage input 1 to 5 VDC (Input impedance: 1 MΩ) PSE31#: Current input 4 to 20 mA DC (Input impedance: 100 Ω)					
No. of inputs	1 input					
Input protection	Over voltage protection (26.4 V max.)					
Hysteresis	Variable					
Switch output	NPN or PNP open collector output, 2 outputs					
Max. load current	80 mA					
Max. applied voltage	30 VDC (NPN output)					
Residual voltage	1 V or less (80 mA load current)					
Output protection	Short circuit protection					
Response time	1 ms or less					
Anti chatter function	Select from 20 ms, 160 ms, 640 ms, 1280 ms					
Repeatability	±0.1% F.S.					
Analogue output	Voltage output	Output voltage: 1 to 5 V (in rated pressure range) Output impedance: approx. 1 kΩ Linearity: ±0.2% F.S. (without sensor) Response time: 150 ms or less				
	Accuracy	±0.6% F.S.	±1.0% F.S.	±1.5% F.S.		
	Current output	Output Current: 4 to 20 mA (in rated pressure range) Max. load impedance: 300 Ω (voltage: 12 VDC) 600 Ω (voltage: 24 VDC) Min. load impedance: 50 Ω Linearity: ±0.2% F.S. (without sensor) Response time: 150 ms or less				
	Accuracy	±1.0% F.S.	±1.5% F.S.	±2.0% F.S.		
Indicator accuracy	±0.5% F.S. ±2 digits	±0.5% F.S. ± 1digit				
LCD display	3 1/2 digits 7-segment display, dual-colour display (Red/Green)					
Indicator	OUT1: ON (Green), OUT2: ON (Red)					
Auto shift input	Non-Voltage input (reed or solid state), Low level input: 5 ms or more, Low level: 0.4 V or less					
Environment	Enclosure	IP40				
	Ambient temperature range	Operation: 0 to 50 °C, Storage: -10 to 60 °C (no condensation or freezing)				
	Ambient humidity range	Operation, Storage: 35 to 85% RH (no condensation)				
	Withstand voltage	1000 VAC, 1 minute between lead block and case				
	Insulation resistance	50 MΩ or more at 500 VDC between lead block and case				
Temperature characteristic	±0.5% F.S. or less of detected pressure (25 °C)					

2 Specifications (continued)

2.2 Applicable Pressure Sensor specifications

Applicable SMC pressure sensor	Rated pressure range	Display / set pressure range	Display / minimum setting unit
PSE550	0 to 2 kPa	-0.2 to 2 kPa	0.01 kPa
PSE531, PSE541, PSE561	0 to -101 kPa	10 to -101 kPa	0.1 kPa
PSE533, PSE543, PSE563, PSE573	-100 to 100 kPa	-101 to 101 kPa	0.2 kPa
PSE532	0 to 100 kPa	-10 to 100 kPa	0.1 kPa
PSE564, PSE574	0 to 500 kPa	-50 to 500 kPa	1 kPa
PSE530, PSE540, PSE560, PSE570	0 to 1 MPa	-0.1 to 1 MPa	0.001 MPa

Warning

Special products (-X) might have specifications different from those shown in this section. Contact SMC for specific drawings.

3 Names and function of parts

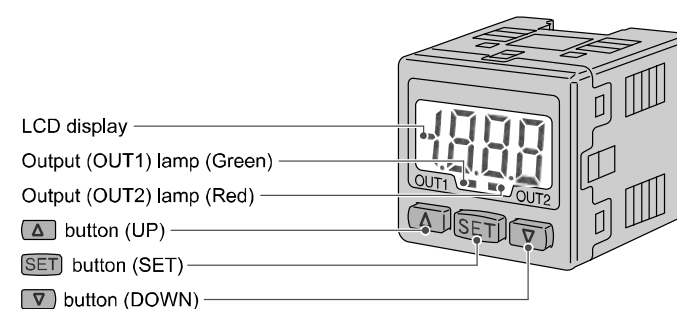

Part	Description
LCD display	Displays the current status of pressure, setting mode, selected indication unit and error codes. Four display modes can be selected: display always in red or green only, or changing from green to red linked to the output.
Output OUT1 lamp (Green)	LED is ON when OUT1 is ON.
Output OUT2 lamp (Red)	LED is ON when OUT2 is ON.
UP button	Selects a mode and increases the ON/OFF value. Press this button to change to peak display mode.
DOWN button	Selects a mode and decreases the ON/OFF value. Press this button to change to bottom display mode.
SET button	Press this button to change mode and to confirm the set value.

4 Installation

4.1 Installation

Warning

- Do not install the product unless the safety instructions have been read and understood.**
- Tighten to the specified tightening torque.**
If the tightening torque is exceeded the mounting screws, brackets and the product can be broken. Insufficient torque can cause displacement of the product from its correct position.
- Do not drop, hit or apply excessive shock to the product.**
Otherwise damage to the internal parts can result, causing malfunction.
- Do not pull the lead wire forcefully, and do not lift the product by pulling the lead wire.**

4 Installation (continued)

4.2 Environment

Warning

- Do not use in an environment where corrosive gases, oil, chemicals, salt water or steam are present.
- Do not use in an explosive atmosphere.
- Do not expose to direct sunlight. Use a suitable protective cover.
- Do not install in a location subject to vibration or impact in excess of the product's specifications.
- Do not mount in a location exposed to radiant heat that would result in temperatures in excess of the product's specifications.

4.3 Mounting with Bracket

- Fix the bracket (part number ZS-28-B) to the controller using the screws M3 x 5 L (2 pcs.) supplied, then mount the product in the required position.
* Tighten the bracket mounting screws to a torque of 0.5 to 0.7 N•m.

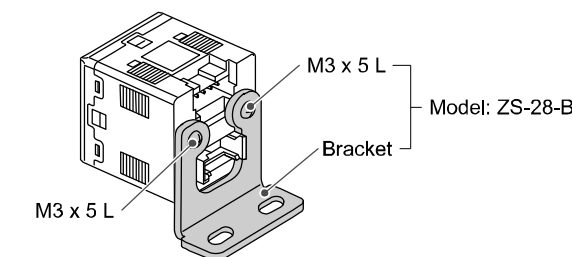

4.4 Mounting with Panel mount adapter

- Mount the panel mount adapter to the front of the controller. Then insert the controller with adapter into the panel until it comes into contact with the panel front surface.
- Next, mount the rear part to the controller and insert it until it comes into contact with the panel.
- Fix the panel mount adapter to the product using the screws M3 x 8 L (2 pcs.) supplied.

- Panel mount adapter + Front protective cover (Part No.: ZS-27-D)

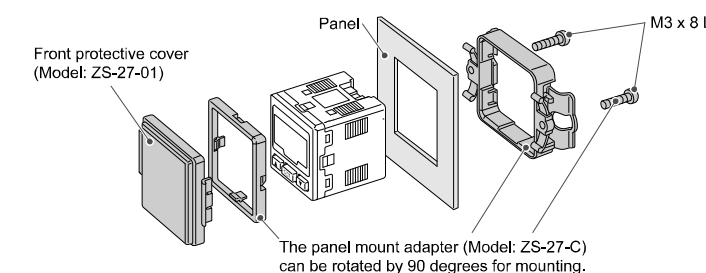

4.5 Removing the panel mounted controller

- When removing the sensor controller with panel mount adapter from the installation, pull it forward while expanding the hooks on each side as shown below.
If the panel mount adapter is pulled forward with the hook caught, the product and the adapter may be damaged.

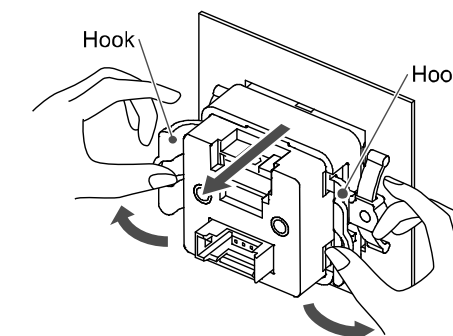

4 Installation (continued)

4.6 Mounting of DIN rail mounted controller (PSE3##T)

- Hook the bottom of the controller body on to the DIN rail as shown (Fig. a) and press it down to fix.
- For removal, unhook it with a flat screw driver as shown (Fig. b).

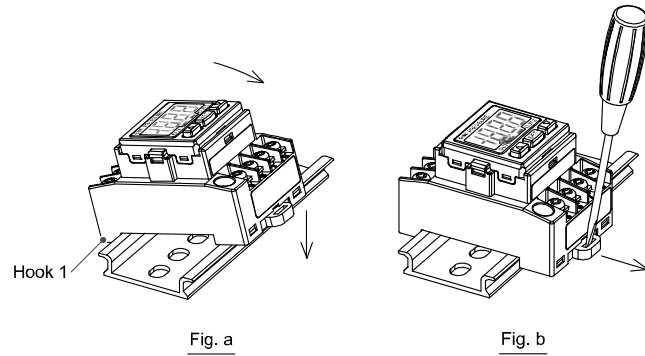

5 Wiring

5.1 Wiring Connection

- Connections should be made with the power supply turned OFF.
- Do not insert or remove the sensor connector with the power ON.
- Use a separate route for the product wiring and any power or high voltage wiring. Otherwise, malfunction may result due to noise.
- If a commercially available switching power supply is used, be sure to ground the frame ground (FG) terminal. If the switching power supply is connected for use, switching noise will be superimposed and it will not be able to meet the product specifications. In that case, insert a noise filter such as a line noise filter/ferrite between the switching power supplies or change the switching power supply to the series power supply.

5.2 Sensor Connector wiring

- Attach the connector to the lead wire. The sensor wire should be stripped as shown in the figure. Do not cut the insulator. Refer to the table below for corresponding connector and wire gauge.

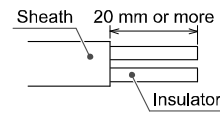

AWG No.	Conductor size (mm ²)	Outer diameter (mm)	Colour	SMC part No.
24-26	0.14-0.2	φ0.8 to φ1.0	Red	ZS-28-C
		φ1.0 to φ1.2	Yellow	ZS-28-C-1
		φ1.2 to φ1.6	Orange	ZS-28-C-2
23	0.1-0.5	φ1.15 to φ1.35	Blue	ZS-28-CA-4
20-22	0.3-0.5	φ1.0 to φ1.2	Green	ZS-28-C-3
		φ1.2 to φ1.6	Blue	ZS-28-C-4
		φ1.6 to φ2.0	Grey	ZS-28-C-5

The corresponding SMC part number and manufacturer number.

SMC part No.	Sumitomo 3M Ltd. part No.	Tyco Electronics AMP K.K. part No.
ZS-28-C	37104-3101-000FL	1-1473562-4
ZS-28-C-1	37104-3122-000FL	—
ZS-28-C-2	37104-3163-000FL	—
ZS-28-CA-4	—	—
ZS-28-C-3	37104-2124-000FL	2-1473562-4
ZS-28-C-4	37104-2165-000FL	—
ZS-28-C-5	37104-2206-000FL	—

5 Wiring (continued)

5.3 Sensor Connector Pin Layout

- The core of the corresponding colour shown in the following table is put into the pin of the number marked on the connector to the bottom.

Connector Pin No.	Wire colour and function		
	PSE30#A (Voltage input)	PSE31#A (Current input)	
		Pressure sensor 2-wire type	Pressure sensor 3-wire type
1	Brown (DC(+))	Brown (LINE(+))	Brown (DC(+))
2	N.C.	N.C.	N.C.
3	Blue (DC(-))	N.C.	Blue (DC(-))
4	Black (OUT: 1 to 5 V)	Blue (LINE(-))	Black (OUT: 4 to 20 mA)

- Check that the above-mentioned wire preparation has been performed correctly, then part A shown in the figure is pushed in by hand to make temporary connection.



- Part A centre should be pressed straight in using a suitable tool, such as pliers. The e-CON connector cannot be re-used once it has been completely crimped.
- In case of connection failure or when a pin is mis-wired, always use a new e-CON connector.
- The wire colours are applicable for an SMC sensor lead wire.

5.4 Power and Output Connector pin layout

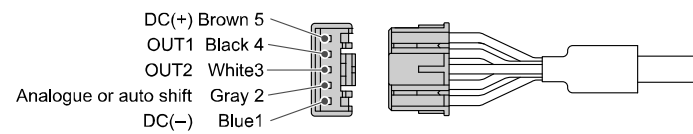

5.5 Connecting / Disconnecting

- When connecting the connector, insert it straight onto the pins while holding the lever and connector body and lock the connector into the square groove in the housing until the connector clicks.
- When removing the connector, press down the lever to disengage the lever claw and pull the connector straight out.

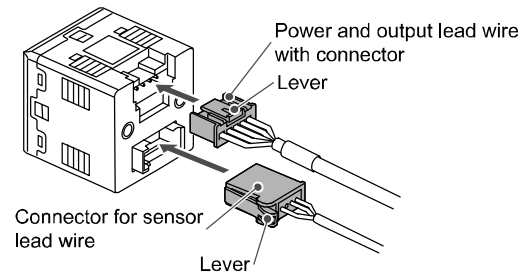

5.6 Wiring of DIN rail mounted PSE3##T

- The terminal screw is M3. If using the crimp terminals, follow the specification below. Tighten the terminal screw to a torque of 0.3 to 0.35 N•m.

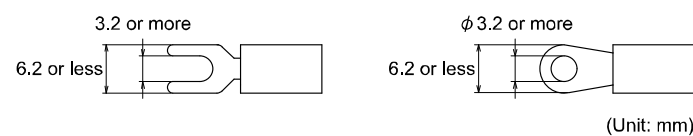

6 Settings procedure

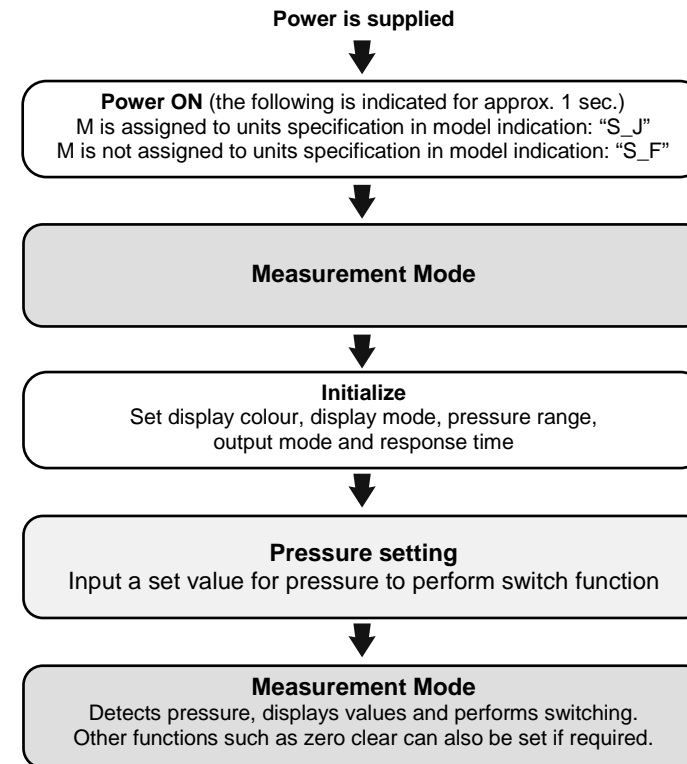

7 Initial Setting

Press and hold the SET button longer than two seconds. Release the SET button when [Sor] is displayed. The initial setting can begin.

1. Display colour setting

Select a colour for the LCD display. To change the display colour, press the UP or DOWN button to select a colour. Press the SET button to set.

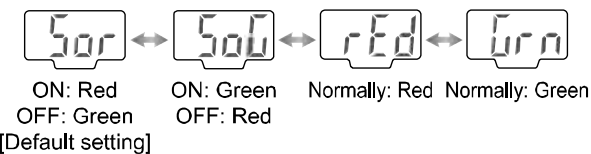

2. Output linked to display colour setting

For selection of Sor and SoG only. Select the output linked to the display colour, press the UP or DOWN button to select the output. Press the SET button to set.

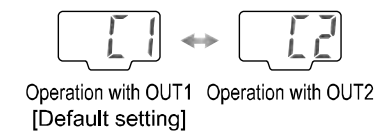

3. Pressure range setting

Select the pressure range suitable for the connected sensor. Press the UP or DOWN button to select the pressure range. Press the SET button to set.

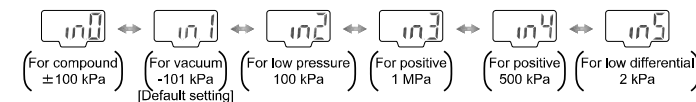

4. Selecting the display units

Use only when the [M] is not assigned to the units specification in model indication. The display units can be selected. Press the UP or DOWN button to select the units. Press the SET button to set.

7 Initial Setting (continued)

5. Output method setting

Four output modes can be selected using the operating mode and output style. One of the four output modes can be selected for each output. OUT1 and OUT2 can be set independently.

- To set the operating mode of OUT1. Press the UP or DOWN button to select hysteresis mode or window comparator mode. Press the SET button to set.
 - Hysteresis mode: 11.9
 - Window comparator mode: 12.0
- To set the output style for OUT1. Press the UP or DOWN button to select normally open or normally closed mode. Press the SET button to set.
 - Normally open mode: 1n0
 - Normally closed mode: 1n1
- To set the operating mode of OUT2. Press the UP or DOWN button and the SET button to set as in OUT1.
 - Hysteresis mode: 21.9
 - Window comparator mode: 21.0
 - Normally open mode: 2n0
 - Normally closed mode: 2n1

6. Response time setting

A response time for switch output can be set as required. Set the optimum response time to prevent chattering of the switch. Press the UP or DOWN button to select the required response time. Press the SET button to set.

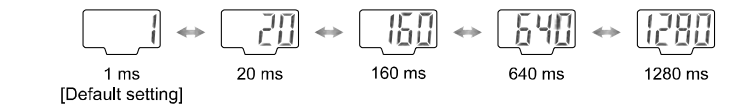

7. Pressure setting.

There are two methods for pressure set-up: manual and auto preset, either one of which can be selected. The auto preset is provided for an automatic optimum set-up by using a sample for a case in which switch output is used to check absorption. The operation mode currently selected is displayed. Press the UP or DOWN button to select the required response time. Press the SET button to set.

When both OUT1 and OUT2 are in window comparator mode this item will not be shown.



8. Auto shift setting

- Select the display mode of the pressure value at the time of auto shift operation. Either [AS (Auto shift)] or [ASO (Auto shift zero)] can be selected. AS (Auto shift): [AS] displays the differential pressure of the atmosphere and measurement pressure. ASO (Auto shift zero): [ASO] displays the differential pressure of the measurement pressure and the measurement pressure at the time of auto shift signal input. Press the UP or DOWN button to select auto shift or auto shift zero. Press the SET button to set.



- Selecting the switches which Auto Shift mode apply, when the auto shift signal is inputted. Press the UP or DOWN button to select the A1, A2 or Ab. Press the SET button to set.

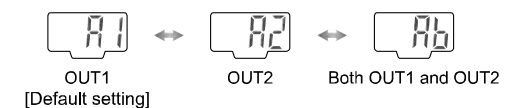

The initial setting is completed and the display will return to Measurement mode.

8 Pressure Setting

8.1 Manual setting

1. Selection of OUT1 [P_1] setting mode

- Press the SET button in Measurement mode to display the set values.
- [P_1] and the current set value will display in turn (when normally closed mode is selected, [n_1] and the set value will display in turn).
- Press the UP or DOWN button to select the value changing mode, then change the set value.
- Check the corrected value, then press the SET button to set.

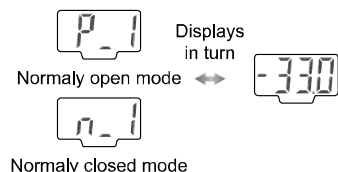

2. Selection of OUT1 [P_2] setting mode

(when window comparator mode is selected).

- [P_2] and the current set value will display in turn. (when normally closed mode is selected, [n_2] and the set value will display in turn).
- Press the UP or DOWN button to select the value changing mode, then change the set value.
- Check the corrected value, then press the SET button to set.

3. Selection of OUT1 [H_1] setting mode

- [H_1] and the current set value will display in turn.
- Press the UP or DOWN button to select the value changing mode, then change the set value.
- Check the corrected value, then press the SET button to set.

4. Selection of OUT2 setting mode

- Set the set values [P_3] [P_4] and [H_2] for OUT2 as in OUT1.
- [P_3] [P_4] or [H_2] and the current set value will display in turn (when normally closed mode is selected, [n_3] [n_4] or [H_2] and the set value will display in turn).
- Press the UP or DOWN button to select the value changing mode,

then change the set value.

- Check the corrected value, then press the SET button to set.

5. Auto shift compensation value setting

(PSE3#2(T) / PSE3#5(T) models only)

- [C_5] and the auto shift corrected value will display in turn.
- Check the corrected value, then press the SET button.

The pressure setting mode is completed and the display will return to Measurement mode.

8.2 Value setting

To input a value for pressure setting or for other purposes:

- Press the UP or DOWN button to enter set value change mode. The 1st digit will flicker.
- Press the UP or DOWN button to set a required value.

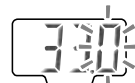

(No operation within thirty seconds after the set value change mode was selected will result in automatic setting of the value appearing in the display window and in changing of the mode from set value change mode to set value display mode).

- Press the SET button to make the value one digit higher flicker.

(If the highest place is zero, [↑] or [↓] will flicker.)

[↑] means "+zero", [↓] means "-zero".

(When the SET button is pressed in the highest place, the 1st digit will flicker).

- Press the SET button continuously for longer than one second to memorize the set value and to return to displaying set values.

Setting example:

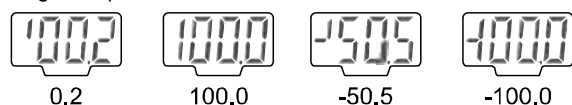

8 Pressure Setting (continued)

8.3 Auto preset function

When auto preset is selected during Initial setting, this function stores in the memory a pressure setting value which is calculated from a measured pressure as a reference value. The set value of the controller is automatically set to an optimum value by repeating absorption and non-absorption several times with a sample which is to be set up.

1. Selection of OUT1 auto preset mode

- Press the SET button to display [AP1]. (when OUT1 setting is not necessary, press the UP button and DOWN button simultaneously for more than one second).

2. Preparation of unit for OUT1

- Prepare a unit for which pressure for OUT1 is to be set.

3. Selection of auto preset value of OUT1 setting

- Press the SET button to display [A1L].
- Operate the system so that pressure may change.
- Detection will be made and a set value will be stored in the memory automatically and display [A1H].

4. Selection of OUT2 auto preset mode

- Press the SET button to set [P_1], [H_1] ([n_1], [H_1] in normally closed mode) to display [AP2]. (when OUT2 setting is not necessary, press the UP and DOWN button simultaneously for more than one second).

5. Preparation of unit for OUT2 and pressure setting

- Prepare a unit for which pressure for OUT2 is to be set. Press the SET button and display [A2L].
- [A2L] is displayed and detection will be carried out and a set value will be stored in the memory automatically and display [A2H].

6. Set up of OUT2 auto preset value

- Press the SET button to set the set value of [P_3], [H_2] ([n_3], [H_2] in normally closed mode), and auto preset mode is finished. The mode will return to the Measurement mode.

A pressure setting value in auto preset is as follows in normally open mode with OUT1.

(P_1 is n_1 in Normally Closed mode with OUT1).

$$P_1 = A - (A - B) / 4 \quad A = \text{maximum pressure value}$$

$$H_1 = (A - B) / 2 \quad B = \text{minimum pressure value}$$

For OUT2 set-up, the above P_1, n_1, and H_1 become P_3, n_3, and H_2 respectively.

9 Other Functions

- Auto shift function
- Peak / Bottom hold display function
- Zero-clear function
- Key-lock function

Refer to the operation manual on the SMC website (URL: <https://www.smcworld.com>) for setting these functions.

10 Outline Dimensions (mm)

Refer to the operation manual or catalogue on the SMC website (URL: <https://www.smcworld.com>) for the Outline Dimensions.

11 How to Order

Refer to the operation manual or catalogue on the SMC website (URL: <https://www.smcworld.com>) for How to Order information.

12 Troubleshooting

12.1 Error indication

Error	Display	Description	Measures
OUT1 Over current error	Er1	The switch output load current is 80 mA or more.	Turn the power off and remove the cause of the over current. Then supply the power again.
OUT2 Over current error	Er2		
Residual pressure error	Er3	During a zero clear operation, pressure over $\pm 7\%$ F.S. is applied. After 3 s, the mode will reset to the measurement mode. The zero clear range varies with individual product differences to ± 4 digits.	Release the applied pressure to atmospheric pressure, and retry the zero clear operation.
Pressure error	HHH	Pressure exceeding the upper limit of the set pressure range is applied.	Reset applied pressure to a level within the set pressure range. Check the sensor connection and wiring.
	LLL	Pressure exceeding the lower limit of the set pressure range is applied. Sensor is not connected or wired incorrectly.	
Auto shift error	or	The measured pressure at auto-shift input has exceeded the set pressure range. * After 1 s, measurement mode returns automatically.	Auto shift input is invalid by connected equipment and system. Check the connected equipment and system.
System error	Er4	Displayed if an internal data error has occurred.	Turn the power off and on again. If the failure cannot be solved, contact SMC.
	Er6		
	Er7		
	Er8		

If the error cannot be reset after the above measures are taken, or errors other than above are displayed, please contact SMC.

13 Maintenance

13.1 General Maintenance

Caution

- Not following proper maintenance procedures could cause the product to malfunction and lead to equipment damage.
- If handled improperly, compressed air can be dangerous.
- Maintenance of pneumatic systems should be performed only by qualified personnel.
- Before performing maintenance, turn off the power supply and be sure to cut off the supply pressure. Confirm that the air is released to atmosphere.
- After installation and maintenance, apply operating pressure and power to the equipment and perform appropriate functional and leakage tests to make sure the equipment is installed correctly.
- If any electrical connections are disturbed during maintenance, ensure they are reconnected correctly and safety checks are carried out as required to ensure continued compliance with applicable national regulations.
- Do not make any modification to the product.
- Do not disassemble the product, unless required by installation or maintenance instructions.

How to reset the product after power cut or forcible de-energizing

The setting of the product will be retained as it was before a power cut or de-energizing. The output condition is also basically recovered to that before a power cut or de-energizing, but may change depending on the operating environment.

Therefore, check the safety of the whole installation before operating the product. If the installation is using accurate control, wait until the product has warmed up (approximately 10 to 15 minutes).

14 Limitations of Use

14.1 Limited warranty and Disclaimer/Compliance Requirements

Refer to Handling Precautions for SMC Products.

15 Product disposal

This product shall not be disposed of as municipal waste. Check your local regulations and guidelines to dispose of this product correctly, in order to reduce the impact on human health and the environment.

16 Contacts

Refer to www.smcworld.com or www.smc.eu for your local distributor / importer.

SMC Corporation

URL: <https://www.smcworld.com> (Global) <https://www.smc.eu> (Europe)
 SMC Corporation, 4-14-1, Sotokanda, Chiyoda-ku, Tokyo 101-0021, Japan
 Specifications are subject to change without prior notice from the manufacturer.
 © 2021 SMC Corporation All Rights Reserved.
 Template DKP50047-F-085M