



Instruction Manual
3-axis Step Motor Controller
EtherNet/IP™ compatible
Series JXC92



The intended use of the 3-axis step motor controller is to control the operation of electric actuators while connected to EtherNet/IP protocol.

1 Safety Instructions

These safety instructions are intended to prevent hazardous situations and/or equipment damage. These instructions indicate the level of potential hazard with the labels of "Caution," "Warning" or "Danger." They are all important notes for safety and must be followed in addition to International Standards (ISO/IEC^{*)}, and other safety regulations. IEC 60204-1: Safety of machinery - Electrical equipment of machines. (Part 1: General requirements)

ISO 10218-1: Robots and robotic devices - Safety requirements for industrial robots - Part 1: Robots.

- Refer to product catalogue, Operation Manual and Handling Precautions for SMC Products for additional information.
- Keep this manual in a safe place for future reference.

Caution	Caution indicates a hazard with a low level of risk which, if not avoided, could result in minor or moderate injury.
Warning	Warning indicates a hazard with a medium level of risk which, if not avoided, could result in death or serious injury.
Danger	Danger indicates a hazard with a high level of risk which, if not avoided, will result in death or serious injury.

Warning

- Always ensure compliance with relevant safety laws and standards.
- All work must be carried out in a safe manner by a qualified person in compliance with applicable national regulations.

2 Specifications

Basic Specifications

Item	Specifications
Number of axes	3 axis maximum
Compatible motor	Step motor (servo 24 VDC)
Encoder	Incremental phase A / B (800 pulse / rotation)
Power supply	24 VDC +/-10% (motor drive control, stop, lock brake release).
Current consumption	500 mA maximum (controller) Refer to the actuator specifications for total power consumption.
Serial communication	USB2.0 (full Speed 12 Mbps)
Memory	Flash ROM
Lock control	Forced lock-release terminal
Cable length	Actuator cable: 20 m maximum
Cooling method	Natural air cooling
Operating temperature	0 to 40°C (No freezing)
Operating humidity	90% RH or less (No condensation)
Storage temperature	-10 to 60°C (No freezing)
Insulation resistance	50MΩ (500 VDC) between the external terminals and case
Weight	600 g (Direct mounting) 650 g (DIN rail mounting)

2 Specifications (continued)

EtherNet/IP Specifications

Item	Specifications
Protocol	EtherNet/IP™ (conformance test version CT13)
Communication speed	10 / 100 Mbps (automatic negotiation)
Communication method	Full duplex / Half duplex (automatic negotiation)
Occupied area	Input 16 bytes / Output 16 bytes
IP address setting range	Manual setting by rotary switches: From 192.168.1.1 to 254 Via DHCP server: Arbitrary address
Vendor ID	7h (SMC Corporation)
Product type	2Bh (Generic Device)
Product code	DEh
EDS set up file	jxc92_v10.eds

Warning

Special products (-X) might have specifications different from those shown in this section. Contact SMC for specific drawings.

3 Name and function of parts

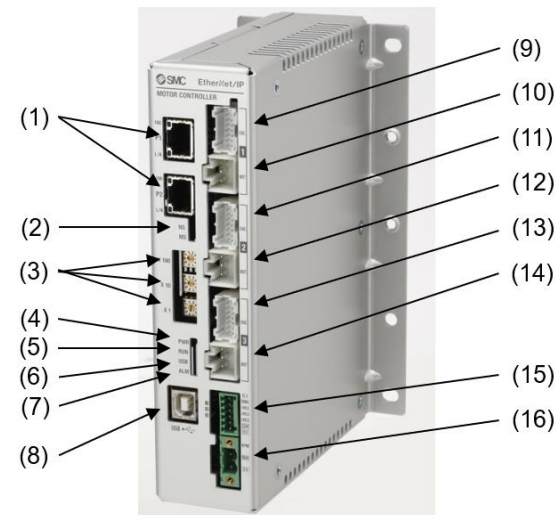

No.	Display	Description	Details
1	P1, P2	EtherNet/IP communication connector	Connection for EtherNet cable
2	MS, NS	Communication status LED	LED to display EtherNet/IP communication status
3	x100 x10 x1	IP address setting switches	Switches to set the IP address (x1, x10, x100).
4	PWR	Power supply LED (green)	LED is ON: Power is ON LED is OFF: Power is OFF
5	RUN	Operating LED (green)	LED is ON: Operation by EtherNet/IP. LED is flashing: Operation by USB communication. LED is OFF: Stop.
6	USB	USB LED (green)	LED is ON: USB connected LED is OFF: USB not connected.
7	ALM	Alarm LED (red)	LED is ON: Alarm generated. LED is OFF: No alarm
8	USB	Serial communication	Connect to a PC using a USB cable.
9	ENC1	Encoder connector (16 pins)	Axis 1: Connect the actuator cable.
10	MOT1	Motor power connector (6 pins)	

Name and function of parts (continued)

No.	Display	Description	Details
11	ENC2	Encoder connector (16 pins)	Axis 2: Connect the actuator cable.
12	MOT2	Motor power connector (6 pins)	
13	ENC3	Encoder connector (16 pins)	Axis 3: Connect the actuator cable.
14	MOT3	Motor power connector (6 pins)	
15	CI	Control power supply connector	Control power supply (+), All axes stop (+), Axis 1 unlock (+), Axis 2 unlock (+), Axis 3 unlock (+), common (-)
16	M PWR	Motor drive power connector	Motor drive power supply (+), Motor drive power supply (-)

The control power supply mating connector and motor drive power mating connector are included with the controller.

4 Installation

4.1 Installation

Warning

- Do not install the product unless the safety instructions have been read and understood.
- Design the installation so that the temperature surrounding the controller is 40°C max. Leave enough space between the controllers so that the operating temperature of the controllers remains within the specification range.
- Mount the controller vertically with 50 mm minimum space on the top and bottom of the controller as shown below.
- Allow 100 mm minimum space between the front of the controller and a door (lid) so that the connectors can be connected and disconnected.

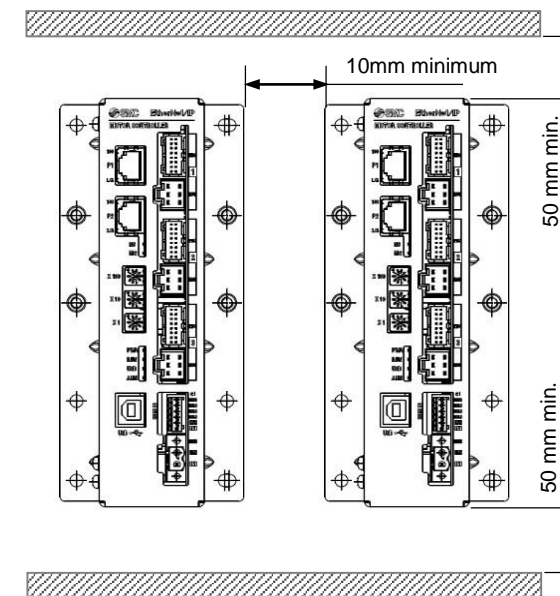

4.2 Mounting

- The controller can be direct mounted using 4 x M5 screws (prepared by the user) or mounted on a DIN rail.
- For DIN rail mounting, secure the DIN rail mounting bracket to the controller using the mounting screws supplied (M5 x 8 mm) in 2 places on each side. Recommended torque: 3.0 N.m.
- Then fit the DIN rail mounting bracket holding screw supplied (M5 x 14 mm) in one place on each side. Tighten approximately 2 turns. Recommended torque: 0.4 to 0.6 N.m.

4 Installation (continued)

(a) Direct Mounting

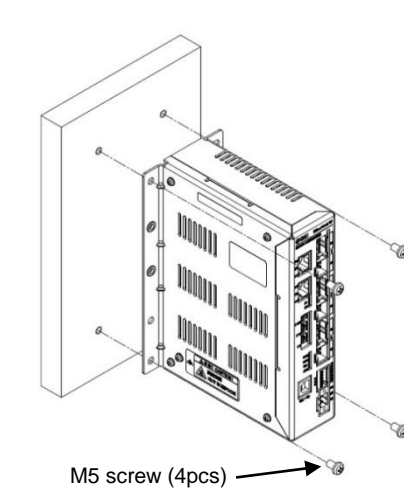

(b) DIN rail mounting

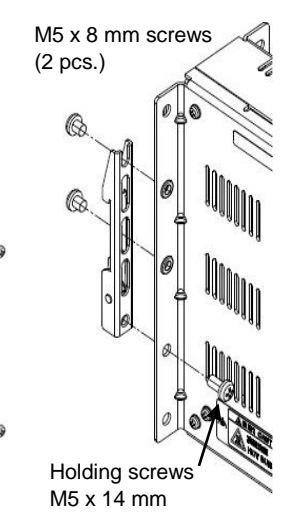

Caution

If the mounting surface for the controller is not flat or is uneven, excessive stress may be applied to the enclosure, which can cause failure. Be sure to mount it on a flat surface.

4.3 Mounting on to DIN rail

The figure below shows how to mount the controller to the DIN rail. Hook part A on to the DIN rail. Press part B on to the DIN rail and then tighten the holding screws (M5 x 14 mm). Recommended torque: 0.4 to 0.6 N.m.

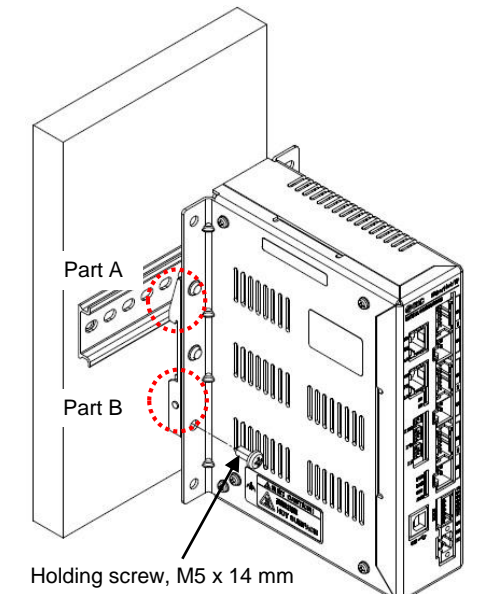

4.4 Ground connection

Fit the grounding cable with crimped terminal between the M3 screw and shakeproof washer as shown below and tighten the screw. The cable and crimped terminal are prepared by the user. The controller must be connected to ground to reduce noise.

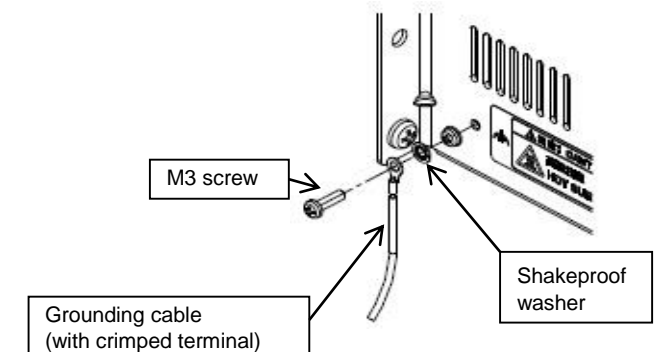

4 Installation (continued)

4.5 Environment



- Do not use in an environment where corrosive gases, chemicals, salt water or steam are present.
- Do not use in an explosive atmosphere.
- Do not expose to direct sunlight. Use a suitable protective cover.
- Do not install in a location subject to vibration or impact in excess of the product's specifications.
- Do not mount in a location exposed to radiant heat that would result in temperatures in excess of the product's specifications.
- Avoid mounting the controller near a vibration source, such as a large electromagnetic contactor or circuit breaker on the same panel.
- Do not use in an environment with strong magnetic fields present.

5 Wiring

5.1 Power supply connector

- Connector specifications

The power supply connector type included is shown below.

(1) Motor drive power connector : M PWR

Manufactured by Phoenix Contact (Part No. MSTB2,5/2-STF-5,08).

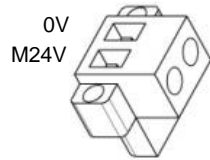

Terminal	Function	Description
0V <small>Note 1)</small>	Motor drive power supply (-)	Power supply side (-) for motor drive.
M24V	Motor drive power supply (+)	Power supply side (+) for motor drive.

Note 1) Motor drive power supply (-) and control power supply (-) are connected inside the controller.

Prepare the electrical wiring according to the following specifications.

Item	Specifications
Applicable wire size	Single, Stranded wire → AWG16 (1.25 mm ²). The rated temperature of the insulation coating should be 60°C or more.
Stripped wire length	

When the wire is inserted into the motor drive power connector, insert only the stripped part of the wire.

(2) Control power supply connector: CI

Manufactured by Phoenix Contact

(Part number FK-MC0,5/6-ST-2,5)

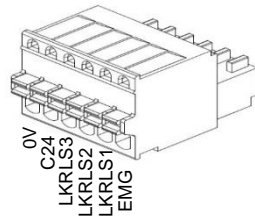

Terminal	Function	Functional explanation
0V <small>Note 1)</small>	Control power supply (-)	Power supply (-) for C24V, LKRLS and EMG.
C24V	Control power supply (+)	Power supply side (+) for control.
LKRLS3	Unlock (+)	Release the lock status (+) of Axis 3.
LKRLS2	Unlock (+)	Release the lock status (+) of Axis 2.
LKRLS1	Unlock (+)	Release the lock status (+) of Axis 1.
EMG	Stop (+)	Release the stop status (+) of All axes. (Normal operation by applying 24V.)

Note 1) Control power supply (-) and motor drive power supply (-) are connected inside the controller.

5 Wiring (continued)

Prepare the electrical wiring according to the following specifications (to be prepared by the user).

Item	Specifications
Applicable wire size	Single, Stranded wire → AWG20 (0.5mm ²), the rated temperature of the insulation coating should be 60°C or more.
Stripped wire length	

Insert only the stripped part of the wire into the connector.

6 Settings

6.1 Switch Setting

- Switch settings should be carried out with the power OFF.
- The switches should be set using a small flat blade screwdriver.

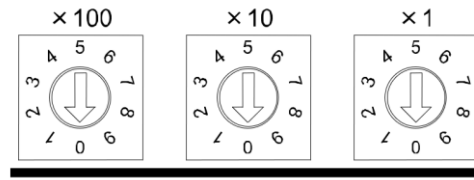

Setting			Description
x100	x10	x1	
0	0	0	Remote Control mode <small>Note 1)</small>
0	0	1	192.168.1.1 (default)
0	0	2	192.168.1.2
:	:	:	:
2	5	4	192.168.1.254
2	5	5	DHCP mode <small>Note 2)</small>
2	5	6	Unused
:	:	:	
9	9	9	

Note *1) The mode to set IP address by DHCP server.

When "BOOTP/DHCP Server" (from Rockwell Automation) is used for IP address setting, it is possible to choose whether or not to obtain an IP address when power is supplied to the controller.

Enable DHCP: Controller acquires an IP address from the DHCP server when power is supplied to the controller. The controller deletes the IP address information when the power supply is disconnected.

Disable DHCP: Controller does not acquire an IP address from the DHCP server when power is supplied to the controller. When the power supply is disconnected, the controller holds the IP address when "Disable DHCP" setting is selected.

Note *2) The mode to set IP address by DHCP server.

The controller acquires an IP address from the DHCP server when power is supplied to the controller after setting the IP address. The controller deletes the IP address information when the power is disconnected.

6.2 Configuration

- An EDS file is required to configure the controller.

Furthermore, icons are necessary for the display icon of the controller on the configurator.

The latest EDS and icon file can be downloaded from the SMC website (URL: <https://www.smcworld.com>).

7 LED Display

Refer to the table below for the LED status.

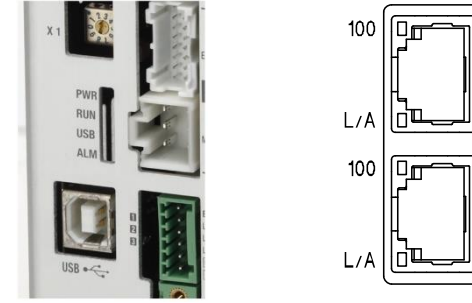

LED	Details		
PWR	Power supply status	Green LED ON	Power is supplied
		OFF	Power is not supplied
RUN	Operation status	Green LED ON	Operating
		Green LED flashing	Operating using the setting software
USB	USB status	Green LED ON	USB connected
		OFF	USB not connected
ALM	Alarm status	Red LED ON	Alarm generated
		OFF	No alarm generated
NS	EtherNet/IP communication status	OFF	Main control power supply is OFF or IP address is not set.
		Green LED ON	Connection is established.
		Green LED flashing	Connection is not established.
		Red LED flashing	Connection time out
MS	EtherNet/IP controller status	Red LED ON	IP duplicated
		OFF	Main control power supply is OFF
		Green LED ON	Operating normally
		Green LED flashing	Setting error
P1 100	EtherNet/IP communication speed	Red LED flashing	Recoverable error
		Red LED ON	Unrecoverable error
P1 L/A	Data transmission status	OFF	10 Mbps
		Orange LED ON	100 Mbps
P2 100	EtherNet/IP communication speed	OFF	Communication is not established. No data transmission.
		Green LED ON	Communication established. No data transmission.
P2 L/A	Data transmission status	Green LED flashing	Communication established. Data transmission in progress.
		OFF	10 Mbps
P2 L/A	Data transmission status	Orange LED ON	100 Mbps
		OFF	Communication is not established. No data transmission.
P2 L/A	Data transmission status	Green LED ON	Communication established. No data transmission.
		Green LED flashing	Communication established. Data transmission in progress.

8 Maintenance

8.1 General Maintenance



- Not following proper maintenance procedures could cause the product to malfunction and lead to equipment damage.
- If handled improperly, compressed air can be dangerous. Maintenance of pneumatic systems should be performed only by qualified personnel.
- Before performing maintenance, turn off the power supply and be sure to cut off the supply pressure. Confirm that the air is released to atmosphere.
- After installation and maintenance, apply operating pressure and power to the equipment and perform appropriate functional and leakage tests to make sure the equipment is installed correctly.
- If any electrical connections are disturbed during maintenance, ensure they are reconnected correctly and safety checks are carried out as required to ensure continued compliance with applicable national regulations.
- Do not make any modification to the product.
- Do not disassemble the product, unless required by installation or maintenance instructions.

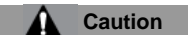

- Maintenance should be performed according to the procedure indicated in the Operation Manual.
- When equipment is serviced, first confirm that measures are in place to prevent dropping of work pieces and run-away of equipment, etc, then cut the power supply to the system. When machinery is restarted, check that operation is normal with actuators in the correct position.



- Perform maintenance checks periodically.
- Confirm wiring and screws are not loose. Loose screws or wires may cause unexpected malfunction.
- Conduct an appropriate functional inspection and test after

completing maintenance. In case of any abnormalities (if the actuator does not move, etc.), stop the operation of the system. Otherwise, an unexpected malfunction may occur and it will become impossible to ensure safety. Operate an emergency stop instruction to confirm safety.

- Do not put anything conductive or flammable inside of the controller.
- Ensure sufficient space around the controller for maintenance.

9 Limitations of Use

9.1 Limited warranty and Disclaimer/Compliance Requirements

Refer to Handling Precautions for SMC Products.

10 Product disposal

This product shall not be disposed of as municipal waste. Check your local regulations and guidelines to dispose of this product correctly, in order to reduce the impact on human health and the environment.

11 Contacts

Refer to www.smcworld.com or www.smc.eu for your local distributor / importer.

SMC Corporation

URL: <https://www.smcworld.com> (Global) <https://www.smc.eu> (Europe)
 SMC Corporation, 4-14-1, Sotokanda, Chiyoda-ku, Tokyo 101-0021, Japan
 Specifications are subject to change without prior notice from the manufacturer.
 © 2021 SMC Corporation All Rights Reserved.
 Template DKP50047-F-085M