

Adsorption Plate

SP Series

Specialized for adsorption and fixing in place of thin sheets, glass substrates, and soft workpieces.

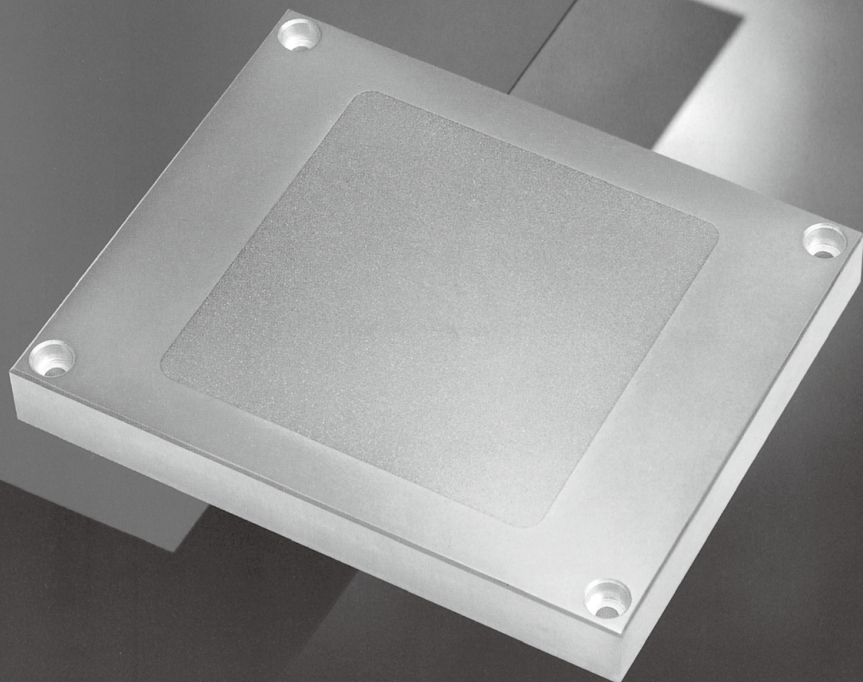

Ideal for adsorption and fixing in place of thin sheets, glass

Adsorption Plate

1 Adsorbs workpieces and holds them in place without leaving wrinkles, air bubbles or marks.

Plate with holes: current

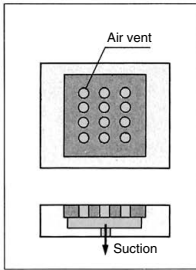

Adsorption Plate

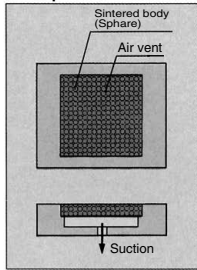

Adsorption of thin sheets

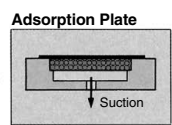
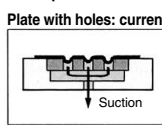

No wrinkles or air bubbles are left on workpiece surfaces.

Adsorption of soft workpieces

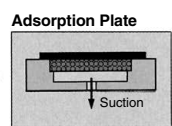
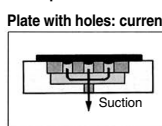

No wrinkles or air bubbles are left on workpiece back side.

2 High processing precision

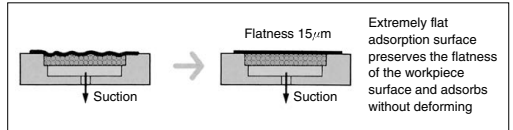
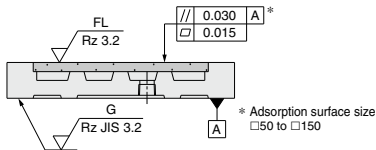

Adsorption surface cross-section

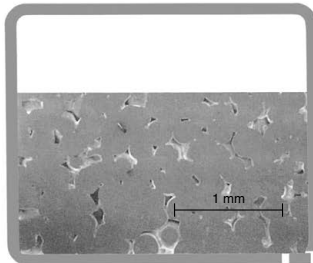
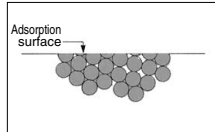

Adsorption surface area Closeup picture

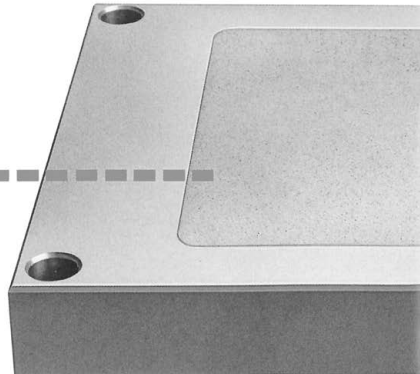
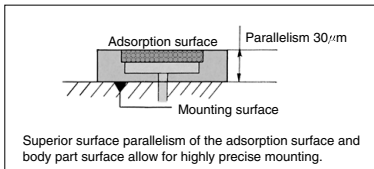

substrates, and soft workpieces.

/SP Series

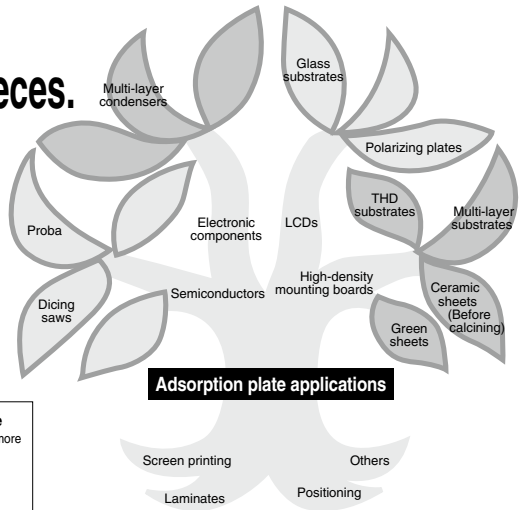

3 High adsorption force Peeling force (F)

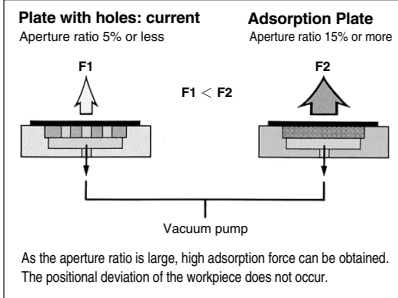

Note) Aperture ratio: The percentage of surface area of the adsorption surface taken up by air vents.

The entire surface area of the adsorption surface contains minute holes of $\varnothing 0.12^*$ at a density of approximately 1,300 holes per square centimeter.

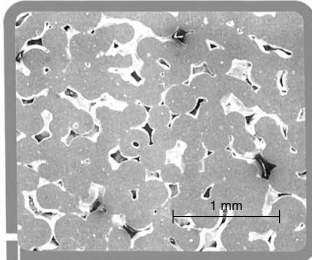

Adsorption surface area
Closeup picture

* This value represents the average diameter when air vents are converted to a circle.

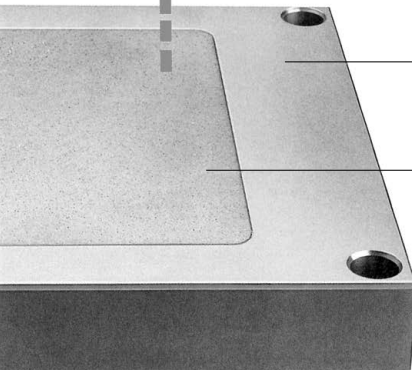

Body part
Aluminum casted

Adsorption surface (Sintered metallic element)
Stainless steel

Adsorption Plate SP Series

RoHS

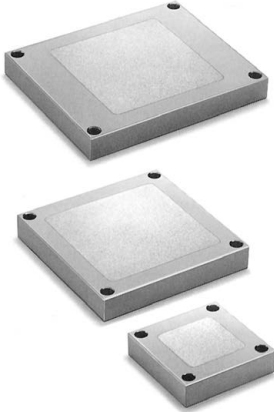

How to Order

SP 1 1 30

Adsorption Plate

Shape

1	Rectangular
2	Square

Sintered metallic element particle diameter

30 ø0.3 standard

Adsorption surface size

1	□ 50 x 50 mm
2	□ 100 x 100 mm
3	□ 150 x 150 mm
4	□ 200 x 200 mm
5	□ 250 x 250 mm
6	□ 300 x 300 mm

- Suitable for adsorption and fixing in place of film and soft sheets
- High processing precision (adsorption surface)
- Large, evenly distributed adsorption force

Standard Specifications

Type	Rectangular	SP1130	SP1230	SP1330	SP1430	SP1530	SP1630
	Square	SP2130	SP2230	SP2330	SP2430	SP2530	SP2630
Flatness (μm, or less)		15	15	15	25	25	25
Parallelism (μm, or less)		30	30	30	40	40	40
Weight (kg)	Rectangular	0.5	1.2	2.1	3.2	5.8	8
	Square	0.4	1.0	1.8	2.9	5.3	7.4
Adsorption surface	Size mm	□ 50 x 50	□ 100 x 100	□ 150 x 150	□ 200 x 200	□ 250 x 250	□ 300 x 300
	Sintered body particle diameter mm	ø0.3 (sphere)					
	Aperture ratio	15% or more					
	Material	Stainless steel					
	Finishing	Wrapping processing					
Body	Material	Aluminum casted					
	Surface processing	Chromated (except for adsorption surface and seating surface)					
	Finishing	Grinding processing					
Ambient temperature °C	10 to 40						
Suction port Rc	1/8						

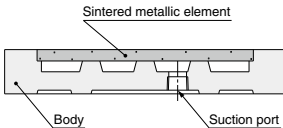

Circuit example

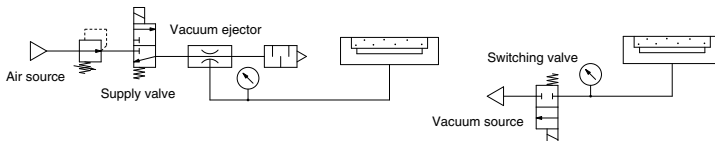

SP Series

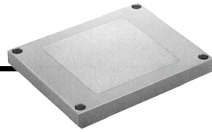

Rectangular/SP1□30

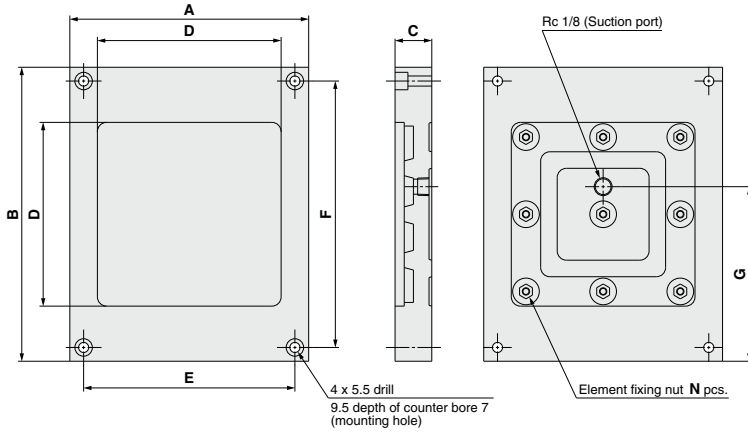

Part no.	Adsorption surface size	A	B	C	D	E	F	G	N
SP1130	□50 x 50	80	110	20	50	65	95	70	5
SP1230	□100 x 100	130	160	20	100	115	145	95	9

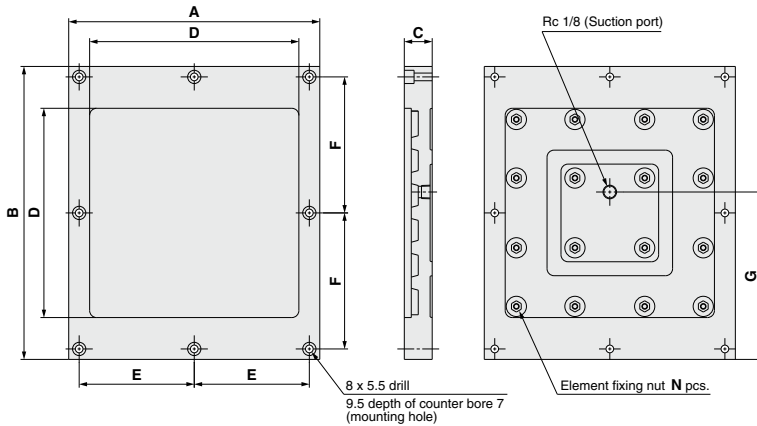

Part no.	Adsorption surface size	A	B	C	D	E	F	G	N
SP1330	□150 x 150	180	210	20	150	82.5	97.5	120	16
SP1430	□200 x 200	230	260	20	200	107.5	122.5	145	25
SP1530	□250 x 250	280	310	25	250	132.5	147.5	170	36
SP1630	□300 x 300	330	360	25	300	157.5	172.5	195	49

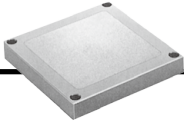

Square/SP2□30

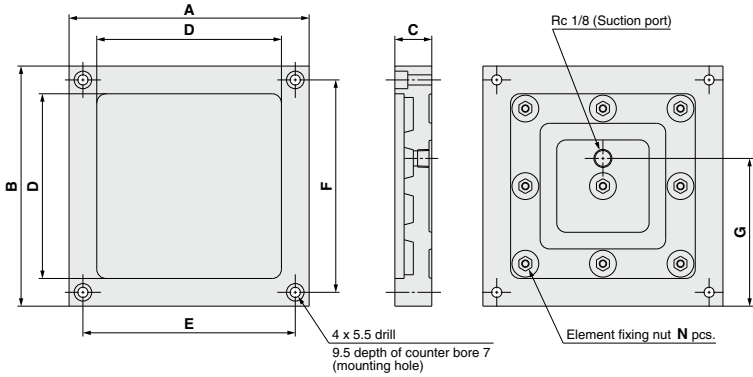

Part no.	Adsorption surface size	A	B	C	D	E	F	G	N
SP2130	□50 x 50	80	80	20	50	65	65	55	5
SP2230	□100 x 100	130	130	20	100	115	115	80	9

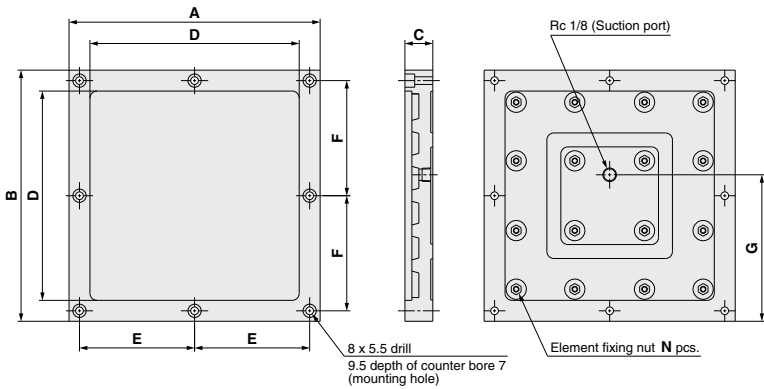

Part no.	Adsorption surface size	A	B	C	D	E	F	G	N
SP2330	□150 x 150	180	180	20	150	82.5	82.5	105	16
SP2430	□200 x 200	230	230	20	200	107.5	107.5	130	25
SP2530	□250 x 250	280	280	25	250	132.5	132.5	155	36
SP2630	□300 x 300	330	330	25	300	157.5	157.5	180	49

SP Series Made to Order

Please contact SMC for detailed specifications, delivery and pricing.



1 Changeable Suction Port Position and Element Type (Particle Diameter)

How to Order

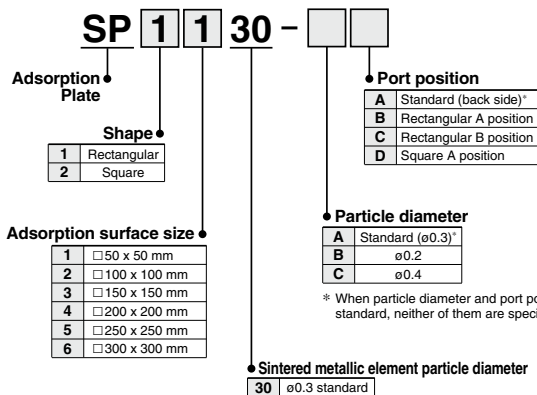

* When particle diameter and port position are both standard, neither of them are specified.

⚠ Caution

- ① This item has made to order specifications including a particle diameter differing from standard items, and a suction port on the side.
- ② Refer to the table for the port position dimensions on the side. The back side port is plugged with a Tapered Screw Plug.
- ③ There are no differences in aperture ratio or adsorption force due to changes in particle diameter of elements.

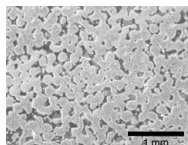

Particle diameter ø0.2

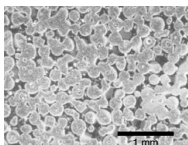

Particle diameter ø0.3

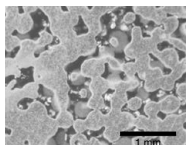

Particle diameter ø0.4

Side Port Position

Rectangular (Select either **A** or **B**.)

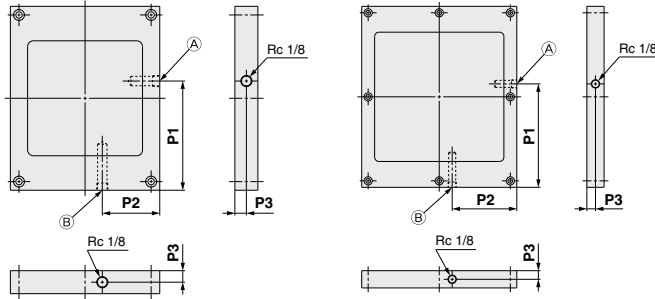

Base part no.	Adsorption surface size	P1	P2	P3
SP1130	□50 x 50	55	40	10
SP1230	□100 x 100	95	50	10
SP1330	□150 x 150	120	75	10
SP1430	□200 x 200	145	100	10
SP1530	□250 x 250	170	125	10
SP1630	□300 x 300	195	150	10

Square

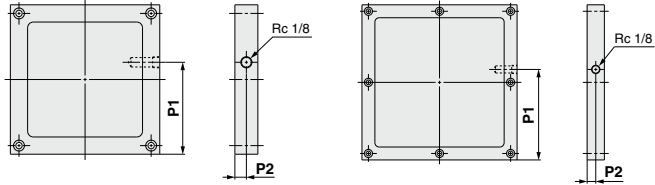

Base part no.	Adsorption surface size	P1	P2
SP2130	□50 x 50	40	10
SP2230	□100 x 100	80	10
SP2330	□150 x 150	105	10
SP2430	□200 x 200	130	10
SP2530	□250 x 250	155	10
SP2630	□300 x 300	180	10

Special Order Products

Products with a stainless steel body or in other shapes can be manufactured. Consult SMC separately.

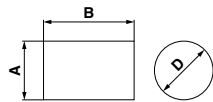

Manufacturable Range

Configuration	Square board		Circular board Diameter øD (mm)
	Perpendicular A (mm) (Dimension classification) under 20 to 50	Horizontal B (mm) (Maximum dimensions) 200 or less	
Body size	under 50 to 100	300 or less	20 to 350
	under 100 to 150	350 or less	
	under 150 to 200	400 or less	
	under 200 to 250	450 or less	
	250 to 370 or less	500 or less	
	Adsorption surface size	The maximum dimensions of the adsorption surface are 5mm less than the each body dimension.	
Body material	Stainless steel Aluminium		

Recommended Body Thickness

Body area (cm ²)	Thickness (mm)	Equivalent size	
		Square board (mm)	Circular board (mm)
100 or less	14	□100 x 100	113
361 or less	16	□190 x 190	214
625 or less	18	□250 x 250	282
900 or less	20	□300 x 300	339
Over 900	23	—	—

* Order a thickness equal to or greater than that shown on the table. If the thickness is less than that shown, the product may not be able to be manufactured, due to warping.

Degree of Flatness (reference value)

Body area (cm ²)	Flatness (mm)		Parallelism (mm)		Equivalent size	
	Stainless steel	Aluminium	Stainless steel	Aluminium	Square board (mm)	Circular board (mm)
529 or less	0.010	0.015	0.02	0.025	□230 x 230	260
1023 or less	0.015	0.02	0.025	0.03	□320 x 320	360
1517 or less	0.020	0.025	0.035	0.04	□370 x 410	—
Over 1517	0.025	0.03	0.045	0.05	—	—

* This table shows the relationship between body area and degree of flatness when square or circular adsorption plates are manufactured at the recommended thickness.



SP Series Specific Product Precautions

Be sure to read this before handling the products.

Caution on Design

⚠ Caution

- Workpieces not able to be fixed in place by suction**
 - Workpieces of a smaller size than the adsorption surface
 - Warped workpieces
 - Workpieces with holes or porous workpieces
 - Workpieces with rough adsorption surfaces, or with vacuum leakage.

- Adsorption force (Theoretical fixing force)**

$$W = P \times S \times K (0.15) \times 0.1$$

W : Adsorption force (N) P : Vacuum pressure (kPa)
S : Adsorption surface area (cm²) K : Aperture ratio 0.15 (15%)

The adsorption force given is calculated on the assumption that 15% of the surface area of the adsorption surface is taken up by air vents. This value should be used as a guideline.

- Vacuum release pressure (Positive pressure)**

After applying suction to the workpiece, when using a vacuum release to add pressure from the suction port, use a pressure of 0.1 MPa or less. Failure to do so may result in a reduction in flatness.

- Definitions of flatness/parallelism**

Flatness: The differential between the maximum and minimum values after plane correction, determined by measuring the adsorption surface side with a 3-D measuring machine.

Parallelism: When measuring the adsorption surface side in the same manner as with the degree of flatness, on the basis of the surface plate of the 3-D measuring machine, this is the differential between the maximum and minimum values of the datum flatness (theoretical flatness) at the point of measurement.

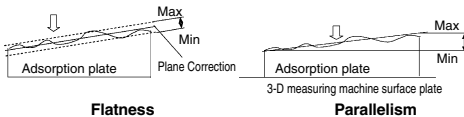

- Do not adsorb and fix the workpiece, and then try to lift it.**

This exerts negative pressure between the workpiece and the workpiece platform, and may make adsorption impossible. Use in such a way that the workpiece is held in place on top of the adsorption plate.

Operating Precautions

⚠ Caution

- Connect vacuum sources such as vacuum pumps and ejectors to the suction port when using.**

The connection port uses an Rc 1/8 taper thread for piping. Be sure to use pipe tape or sealant when connecting.

- The ambient temperature range should be from 10 to 40°C. Do not apply heat to the adsorption plate.**

This may result in a reduction in flatness.

- When mounting to equipment, use M5 hexagon socket head bolts, and fix the adsorption plate on a surface with a high degree of flatness.**

Mounting on a surface with a low degree of flatness may result in a reduction in flatness of the adsorption surface.

Operating Precautions

⚠ Caution

- Do not carry out additional processing on the adsorption plate.**

Deformation resulting from processing may cause a reduction in flatness.

- Dust may be produced from the adsorption part.**

Cutting particles and fluids may remain and they cannot be removed completely. Such foreign objects may stick to the workpiece.

- Do not apply a pressure or load of 0.1 MPa or more to the adsorption surface.**

Doing so may cause a reduction in flatness, damage, or impact marks.

- The body is made of aluminum (casted) and the adsorption face and seating surface are untreated, meaning that discoloration or corrosion may result if it is used in an environment with water or oil splatters, or very high humidity.**

Even when it is used indoors, discoloration may occur if used over long periods of time.

- A clearance of up to 0.2 mm may be opened in the outer periphery of the element.**

⚠ Warning

- Use the adsorption plate to fix the workpiece in place.**

Do not use it to adsorb and transport workpieces. If such use is unavoidable, be sure to mount appropriate hardware to prevent the workpieces from falling.

Cleaning

⚠ Caution

- If foreign particles attach to the adsorption surface, remove them by blowing with clean air.**

- Do not conduct immersion cleansing with solvents, etc.**

Doing so may cause swelling and degradation of the adhesives used, and may result in a vacuum leakage or reduction in flatness.

- Restrict use of solvents to just wiping down with alcohol.**

When doing so, do not use a fibrous cloth. The fabric may become stuck in the air vents and become debris.

Storage

⚠ Caution

- Store in a normal indoor environment.**

Storing in an environment where there is splashing of water or oil, etc., may result in discoloration or corrosion.

- Do not place objects on top of the adsorption plate.**

Doing so may result in a reduction in flatness.