

# Check Valve AK Series

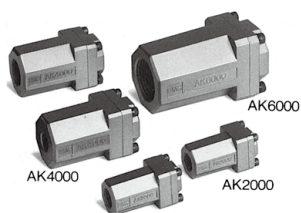

**Large flow capacity**  
**Low cracking pressure: 0.02 MPa**  
**A wide variation of models**



## Model

Model	Port size	Sonic conductance dm <sup>3</sup> /(s·bar)	Critical pressure ratio	Weight (g)
AK2000-01	1/8	5	0.25	105
AK2000-02	1/4	5.5		100
AK4000-02	1/4	9.4		155
AK4000-03	3/8	17		150
AK4000-04	1/2	19		140
AK6000-06	3/4	40		345
AK6000-10	1	46		315

## Specifications

Fluid	Air
Proof pressure	1.5 MPa
Maximum operating pressure	1 MPa
Minimum operating pressure	0.02 MPa
Ambient and fluid temperature	-5 to 60°C (No freezing)

## Symbol

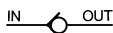

## How to Order

AK **2** 000 - **02**

### Standard size

2	1/4
4	1/2
6	1

### Thread type

NII	Rc
N	NPT
F	G

### Port size

Port size	Applicable series
01	1/8 AK2000
02	1/4 AK2000, 4000
03	3/8 AK4000
04	1/2 AK4000
06	3/4 AK6000
10	1 AK6000

## Flow Rate Characteristics

Note) The flow rate characteristics are representative values.

AK2000-01/02 -- 1/8, 1/4

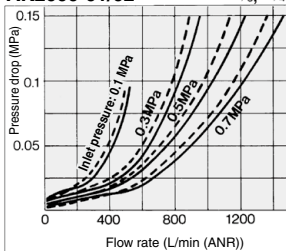

AK4000-02

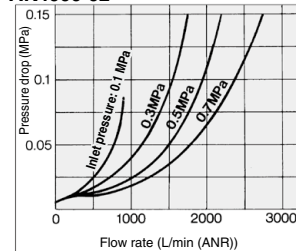

AK4000-03/04 -- 3/8, 1/2

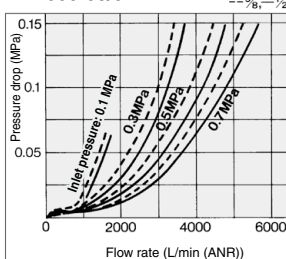

AK6000-06/10 -- 3/4, 1

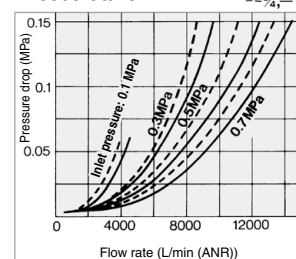

## Construction

### AK2000

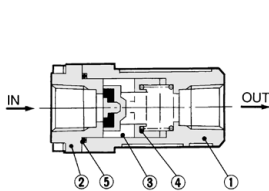

### AK4000/6000

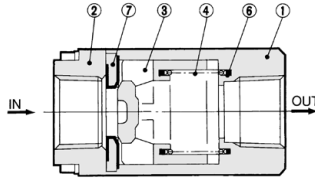

## Component Parts

No.	Description	Material
1	Body	Aluminum die-casted
2	Cover	Aluminum die-casted <small>Note 1)</small>

Note 1) AK2000: Zinc alloy

## Replacement Parts

No.	Description	Material	Part no.		
			AK2000	AK4000	AK6000
3	Valve	POM	19033	19014	19024
4	Spring	Stainless steel	19037	19015	19025
5	O-ring	NBR	KA00294 20 x 17 x 1.5	—	—
6	Ring	NBR	—	19016	19026
7	Seat ring	Brass, NBR	—	19013	19023

## Dimensions

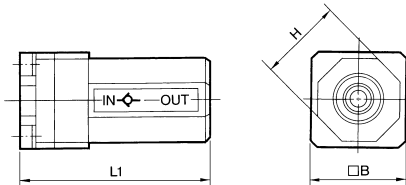

Model	Port size	L1	□B	H
AK2000-01, 02	1/8, 1/4	50	25	22
AK4000-02, 03, 04	1/4, 3/8, 1/2	67	36	36
AK6000-06, 10	3/4, 1	95	50	50

## ⚠ Specific Product Precautions

Be sure to read this before handling the products.  
 Refer to back page 50 for Safety Instructions and pages 543 to 546 for Flow Control Equipment Precautions.

## Design/Selection

## ⚠ Caution

1. Even when using with the specification range listed in the catalog, when the IN side of the check valve is throttled, it may fail to open all the way and may generate vibration.
2. The minimum operating pressure is the pressure when the valve begins to open, and not the pressure when the valve is fully open.
3. The check valve has a construction, in which it is closed by the differential pressure generated when the inlet pressure (IN side) or outlet pressure (OUT side) solenoid valve is switched. Be aware that the check valve does not close completely and the outlet pressure (OUT side) may drop when the inlet pressure (IN side) drops gently and the differential pressure becomes smaller than the minimum operating pressure or cracking pressure.
4. It can not be sealed of valve by only built-in spring, so please use in an environment where differential pressure is generated.
5. Check valve can not be used for relief valve applications. Please use pressure control valve.

AS-F
TMH
ASD
AS
AS-FE
KE
AS-FG
AS-FP
AS-FM
AS-D
AS-T
ASP
ASN
AQ
ASV
AK
VCHC
ASR
ASQ



# Bushing Type Check Valve with One-touch Fittings

## AKH/AKB Series

RoHS

3 configurations provide design solutions based on the operating conditions.



### Straight type

Easily installed in pipe lines.

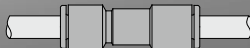

### Male connector type

Can be used directly on equipment.

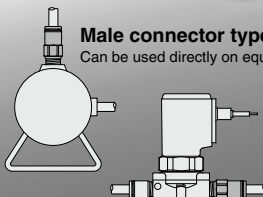

### Bushing type

Can be used in applications with splashing coolant and spatter, etc.

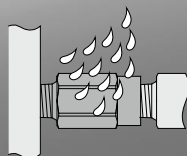

Can be used for vacuum ( $-100$  kPa)

Free flow direction

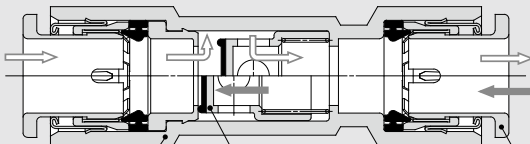

Check direction

### Compact & lightweight

Outside diameter:  $\phi 11.6$  mm  
Overall length: 37.1 mm  
Weight: 5 g  
(for AKH06-00)

### Valve

Low cracking pressure: 0.005 MPa

### With One-touch fitting

Reduces piping labor  
Release bushing color  
Metric size: White  
Inch size: Orange

Symbol

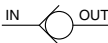

AS-F

TMH

ASD

AS

AS-FE

KE

AS-FG

AS-FP

AS-FM

AS-D

AS-T

ASP

ASN

AQ

ASV

AK

VCHC

ASR

ASQ

# Bushing Type Check Valve with One-touch Fittings

## AKH/AKB Series



### How to Order

Straight type **AKH04** - 00

Male connector type **AKH04 A** - **01 S**

Applicable tubing O.D.

Metric size	Inch size
04	ø4
06	ø6
08	ø8
10	ø10
12	ø12
03	ø5/32
07	ø1/4
09	ø5/16
11	ø3/8
13	ø1/2

• With seal (Standard)  
\* M5 and 10-32 UNF types are not required.

• Thread type

Nil	Metric thread (M5)
	Unified thread (10-32 UNF)
	R
N	NPT

• Port size

M5	M5 x 0.8
U10/32	10-32 UNF
01	1/8
02	1/4
03	3/8
04	1/2

Check valve free flow direction

A	From male thread to One-touch fitting	
B	From One-touch fitting to male thread	

### Applicable Tubing O.D./Port Size Combinations

Metric size	Model	Applicable tubing O.D.	Rt thread				Model	Applicable tubing O.D.	NPT thread					
			M5	1/8	1/4	3/8			1/2	10-32 UNF	1/8	1/4	3/8	1/2
	AKH04□	ø4	●	●			AKH03□	ø5/32	●	●				
	AKH06□	ø6	●	●	●		AKH07□	ø1/4	●	●				
	AKH08□	ø8		●	●		AKH09□	ø5/16		●	●			
	AKH10□	ø10			●	●	AKH11□	ø3/8			●	●	●	
	AKH12□	ø12				●	AKH13□	ø1/2				●	●	

Bushing type **AKB01** A - **01 S**

• Body size

01	1/8
02	1/4
03	3/8
04	1/2

• With seal (Standard)

• Thread type

Nil	R
N	NPT

• Port size

01	1/8
02	1/4
03	3/8
04	1/2

Check valve free flow direction

A	From male to female thread	
B	From female to male thread	

### Female/Male Threads Combinations

R thread					NPT thread						
Model	Female thread Rc	Male thread R			Model	Female thread NPT	Male thread NPT				
		1/8	1/4	3/8	1/2		1/8	1/4	3/8	1/2	
AKB01□	1/8	●				AKB01□	1/8	●			
AKB02□	1/4		●			AKB02□	1/4		●		
AKB03□	3/8			●		AKB03□	3/8			●	
AKB04□	1/2				●	AKB04□	1/2				●

# Bushing Type Check Valve with One-touch Fittings **AKH/AKB Series**



## Specifications

Fluid	Air
Proof pressure	1.5 MPa
Operating pressure range	-100 kPa to 1 MPa
Cracking pressure	0.005 MPa (Note 1)
Ambient temperature and operating fluid temperature	-5 to 60°C (No freezing)
Applicable tubing material (Note 2)	Nylon, Soft nylon, Polyurethane

Note 1) The valve does not open fully at this pressure level.

Note 2) Use caution regarding the max. operating pressure when soft nylon or polyurethane tubing is used.

(Refer to pages 464 and 465 for details.)

## Application Example for Bushing Type Check Valve with One-touch Fittings

### Prevention of reverse flow to vacuum source \* (Simple vacuum holding)

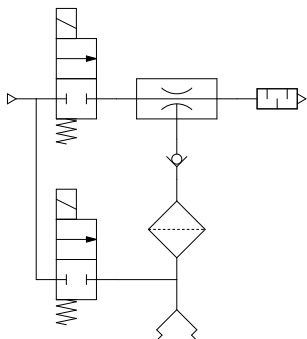

### Tank pressure reverse flow prevention

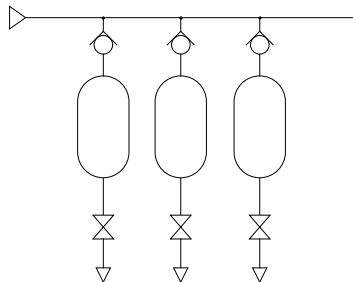

### Drop prevention \*

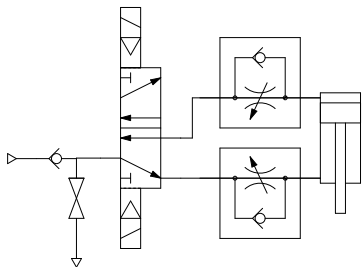

\* A certain amount of leakage is allowed in the specifications of this product. Please note that it is not suitable for holding over an extended period of time.

## ⚠ Specific Product Precautions

Be sure to read this before handling the products.  
Refer to back page 50 for Safety Instructions and pages 543 to 546 for Flow Control Equipment Precautions.

### Design/Selection

## ⚠ Caution

1. Even when using with the specification range listed in the catalog, when the IN side of the check valve is throttled, it may fail to open all the way and may generate vibration.
2. The cracking pressure is the pressure when the valve begins to open, and not the pressure when the valve is fully open.
3. The check valve has a construction, in which it is closed by the differential pressure generated when the inlet pressure (IN side) or outlet pressure (OUT side) solenoid valve is switched. Be aware that the check valve does not close completely and the outlet pressure (OUT side) may drop when the inlet pressure (IN side) drops gently and the differential pressure becomes smaller than the minimum operating pressure or cracking pressure.
4. It can not be sealed of valve by only built-in spring, so please use in an environment where differential pressure is generated.
5. Check valve can not be used for relief valve applications. Please use pressure control valve.

# AKH/AKB Series

## Dimensions

### Straight type: AKH

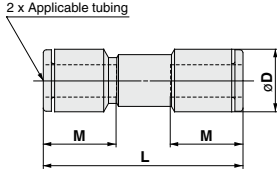

#### Metric Size

Applicable tubing O.D.	Model	øD	L	M	Sonic conductance dm <sup>3</sup> /(s·bar)	Critical pressure ratio	Weight (g)
4	AKH04-00	9.3	33.5	12.7	0.56	0.35	3
6	AKH06-00	11.6	37.1	13.5	1.3		5
8	AKH08-00	15.2	53.3	18.5	2.8		10
10	AKH10-00	18.5	63.6	21	4.8	0.5	17
12	AKH12-00	21.7	70.2	22	6.8		25

#### Inch Size

Applicable tubing O.D.	Model	øD	L	M	Sonic conductance dm <sup>3</sup> /(s·bar)	Critical pressure ratio	Weight (g)
5/32	AKH03-00	9.3	33.5	12.7	0.56	0.35	3
1/4	AKH07-00	12	39	13.6	1.3		6
5/16	AKH09-00	15.2	53.3	18.5	2.8		10
3/8	AKH11-00	18.5	63.6	21	4.8	0.5	17
1/2	AKH13-00	21.7	70.2	22	6.8		24

### Male connector type: AKH

<For M5, UNF10-32>

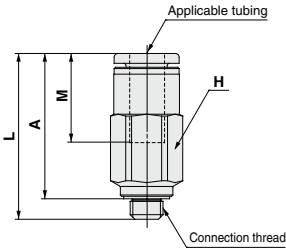

#### Metric Size

Applicable tubing O.D.	Connection thread R	Model	H (Hexagon with across flats)	L	A*	M	Sonic conductance dm <sup>3</sup> /(s·bar)	Critical pressure ratio	Weight (g)
4	M5 x 0.8	AKH04□-M5	8	24.3	21.2	12.7	0.56	0.35	5
	1/8	AKH04□-01S	10	24.6	20.6				10
6	M5 x 0.8	AKH06□-M5	10	25.8	22.2	13.5	0.56		8
	1/8	AKH06□-01S		26.9	22.9				1.3
	1/4	AKH06□-02S	14	30	24	17	1.3		16
8	1/8	AKH08□-01S	14	31.7	27.7	18.5	2.8		24
	1/4	AKH08□-02S	17	42	36			43	
	3/8	AKH08□-03S		35.5	45				
10	1/4	AKH10□-02S	17	54.3	48.3	21	4.8	45	
	3/8	AKH10□-03S	22	47.3	40.8			39	
	1/2	AKH10□-04S		49.3	41.3	80			
12	3/8	AKH12□-03S	19	60.5	54	22	6.8	62	
	1/2	AKH12□-04S	22	54.5	46.5			80	

\* Reference dimensions of R thread after installation.

#### Inch Size

Applicable tubing O.D.	Connection thread NPT	Model	H (Hexagon with across flats)	L	A*	M	Sonic conductance dm <sup>3</sup> /(s·bar)	Critical pressure ratio	Weight (g)
5/32	10-32 UNF	AKH03□-U10/32	8	24.3	21.2	12.7	0.56	0.35	5
	1/8	AKH03□-N01S	11.11	24.6	20.6				10
1/4	10-32 UNF	AKH07□-U10/32	11.11	25.8	22.2	13.6	0.56		10
	1/8	AKH07□-N01S		26.9	22.9				1.3
	1/4	AKH07□-N02S	14.29	31	25	17	1.3		18
5/16	1/8	AKH09□-N01S	14.29	31.7	27.7	18.5	2.8		16
	1/4	AKH09□-N02S	17.46	42	36			24	
	3/8	AKH09□-N03S		35.5	43				
3/8	1/4	AKH11□-N02S	17.46	54.2	48.3	21	4.8	47	
	3/8	AKH11□-N03S	22.23	47.2	40.7			40	
	1/2	AKH11□-N04S		49.2	41.2	79			
1/2	3/8	AKH13□-N03S	22.23	60.5	54	22	6.8	87	
	1/2	AKH13□-N04S	22.23	54.5	46.5			85	

\* Reference dimensions of NPT thread after installation.

<For R, NPT>

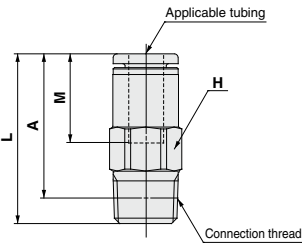

### Bushing type: AKB

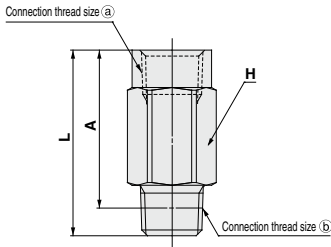

#### Metric Size

Connection thread size R	Model	H	L	A*	Sonic conductance dm <sup>3</sup> /(s·bar)	Critical pressure ratio	Weight (g)
(a) 1/8 (b) 1/8	AKB01□-01S	14	23.7	19.7	1.3	0.35	18
1/4 1/4	AKB02□-02S	17	39.8	33.8	2.8		44
3/8 3/8	AKB03□-03S	22	45.2	38.7	4.8		86
1/2 1/2	AKB04□-04S	24	56.2	48.2	6.8	113	

\* Reference dimensions of R thread after installation.

#### Inch Size

Connection thread size NPT	Model	H	L	A*	Sonic conductance dm <sup>3</sup> /(s·bar)	Critical pressure ratio	Weight (g)
(a) 1/8 (b) 1/8	AKB01□-N01S	14.29	24.2	20.2	1.3	0.35	18
1/4 1/4	AKB02□-N02S	17.46	40	34	2.8		44
3/8 3/8	AKB03□-N03S	22.23	44.9	38.4	4.8		86
1/2 1/2	AKB04□-N04S	23.81	55.5	47.5	6.8	113	

\* Reference dimensions of NPT thread after installation.

## Construction

### Straight type: AKH

ø4, ø6  
ø5/32, ø1/4

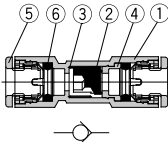

ø8, ø10, ø12  
ø5/16, ø3/8, ø1/2

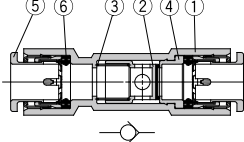

### Component Parts

No.	Description	Material	Note
1	Body	PBT	
2	Valve	NBR, Aluminum alloy	
3	Spring	Stainless steel	
4	Spacer	Brass	Electroless nickel plated
5	Cassette	—	
6	Seal	NBR	

### Male connector type: AKH

	M5 type U10/32	ø4, ø6 ø8 x R1/8 ø5/32, ø1/4 ø5/16 x NPT1/8	ø8, ø10, ø12 ø5/16, ø3/8, ø1/2
Free flow One-touch fitting ↑ Male thread			
Free flow One-touch fitting ↓ Male thread			

### Component Parts

No.	Description	Material	Note
1	Body	Brass	Electroless nickel plated
2	Valve	NBR, Aluminum alloy	
3	Spring	Stainless steel	
4	Spacer	Brass	Electroless nickel plated
5	Stopper	Stainless steel	
6	O-ring	NBR	
7	Cassette	—	
8	Seal	NBR	
9	Gasket	Stainless steel + NBR	

### Bushing type: AKB

	R1/8 NPT1/8	R1/4, 3/8, 1/2 NPT1/4, 3/8, 1/2
Free flow Female thread ↑ Male thread		
Free flow Female thread ↓ Male thread		

### Component Parts

No.	Description	Material	Note
1	Body	Brass	Electroless nickel plated
2	Valve	NBR, Aluminum alloy	
3	Spring	Stainless steel	
4	Spacer	Brass	Electroless nickel plated
5	Stopper	Stainless steel	
6	O-ring	NBR	



# Check Valves For Air/Water

# Made to Order Specifications

Please contact SMC for detailed dimensions, specifications and lead times.



- **Body material: Brass/Stainless steel (Main parts: Stainless steel)**
- **Low cracking pressure: 0.01 MPa**
- **High temperature: 80°C**  
     **Low temperature: -30°C**
- **Rubber material: NBR/FKM/CR**



## Specifications/Models

Model	Port size	Specifications					Fluid	Operating temperature range (°C)	Minimum operating pressure (MPa)	Application	
		Body Brass	All stainless steel	Low cracking pressure 0.01 MPa	Main parts: Stainless steel	Rubber material					
INA-14-290	01: Rc 1/8	●			●	NBR	Air/Water	-5 to 60	0.02		
INA-14-47-□	02: Rc 1/4 03: Rc 3/8 04: Rc 1/2		●			NBR	Air/Water	-5 to 60	0.05	Anti-corrosion	
INA-14-85-□			●			FKM	Air/Water	-5 to 80	0.05	Anti-corrosion	
XTO-674-□			●				NBR	Air	-5 to 60	0.05	Basic type
XTO-674-□A			●			●	NBR	Air/Water	-5 to 60	0.05	For water
XTO-674-□E			●		●		NBR	Air	-5 to 60	0.01	For vacuum, oscillation measures
XTO-674-□H			●				FKM	Air	-5 to 80	0.05	For high temperature
XTO-674-□L			●				CR	Air	-30 to 60	0.05	For low temperature
XTO-674-□AE			●		●	●	NBR	Air/Water	-5 to 60	0.01	
XTO-674-□AH			●			●	FKM	Air/Water	-5 to 80	0.05	
XTO-674-□AL			●			●	CR	Air	-30 to 60	0.05	
XTO-674-□EH			●		●		FKM	Air	-5 to 80	0.01	
XTO-674-□EL			●		●		CR	Air	-30 to 60	0.01	
XTO-674-□AEH			●		●	●	FKM	Air/Water	-5 to 80	0.01	
XTO-674-□AEL			●		●	●	CR	Air	-30 to 60	0.01	

## INA-14-290 (Body material: Brass)



### Specifications

Fluid	Air/Water
Proof pressure	1.5 MPa
Operating pressure range	0.02 to 1 MPa
Ambient and fluid temperature	-5 to 60°C (No freezing)
Port size	2 x Rc 1/8
Sonic conductance	1.25 dm <sup>3</sup> /(s·bar)
Critical pressure ratio	0.45

### Construction/Dimensions

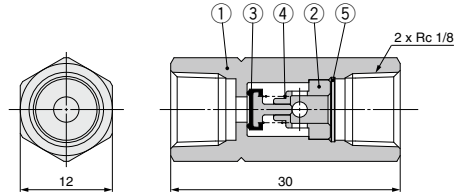

Symbol

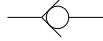

Weight: 20 g

### How to Order

# INA-14-290

### Component Parts

No.	Description	Material	Note
1	Body	Brass	Electroless nickel plating
2	Guide	Brass	Electroless nickel plating
3	Valve	Stainless steel 303, NBR	
4	Spring	Stainless steel 304	
5	Basic internal retaining ring	Stainless steel 304	

## INA-14-□ (All stainless steel)



### Specifications

Model		INA-14-47	INA-14-85
Fluid		Air/Water	
Operating pressure range		0.05 to 1 MPa	
Proof pressure		1.5 MPa	
Ambient and fluid temperature		-5 to 60°C (No freezing)	-5 to 80°C (No freezing)
Valve seal material		NBR	FKM
Port size		Rc 1/4, Rc 3/8, Rc 1/2	
Sonic conductance	Rc 1/4	9.5 dm <sup>3</sup> /(s·bar)	
	Rc 3/8, Rc 1/2	10.5 dm <sup>3</sup> /(s·bar)	
Critical pressure ratio		0.45	

### Construction/Dimensions

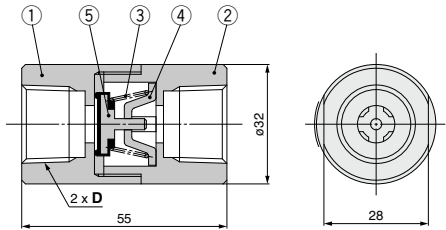

Symbol

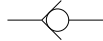

### How to Order

# INA-14-47-02

Series

47	Seal material: NBR
85	Seal material: FKM

Port size

02	Rc 1/4
03	Rc 3/8
04	Rc 1/2

Part no.		D	Weight (g)
INA-14-47-02	INA-14-85-02	Rc 1/4	260
INA-14-47-03	INA-14-85-03	Rc 3/8	240
INA-14-47-04	INA-14-85-04	Rc 1/2	210

### Component Parts

No.	Description	Material
1	Body A	Stainless steel 303
2	Body B	Stainless steel 303
3	Check valve spring	Stainless steel 304
4	Stopper	Stainless steel 304
5	Valve	Stainless steel 303, NBR
		Stainless steel 303, FKM

# XTO-674-□□

## XTO-674-□□ (Body material: Brass)



### Specifications

Model		XTO-674-□	XTO-674-□A	XTO-674-□E	XTO-674-□H	XTO-674-□L
Fluid		Air	Air/Water	Air		
Proof pressure		1.5 MPa				
Operating pressure range		0.05 to 1 MPa	0.01 to 1 MPa	0.05 to 1 MPa		
Ambient and fluid temperature		-5 to 60°C (No freezing)			-5 to 80°C (No freezing)	-30 to 60°C (No freezing)
Port size		Rc 1/4, Rc 3/8, Rc 1/2				
Sonic conductance	Rc 1/4	9.5 dm <sup>3</sup> /(s·bar)				
	Rc 3/8, Rc 1/2	10.5 dm <sup>3</sup> /(s·bar)				
Critical pressure ratio		0.45				

Note) Refer to "Specifications/Models" on page 790 for combinations of each option.

### How to Order

XTO-674-**02**□□

Port size

<b>02</b>	Rc 1/4
<b>03</b>	Rc 3/8
<b>04</b>	Rc 1/2

Option

Symbol	Specifications	Operating temperature range	Minimum operating pressure
<b>Nil</b>	Basic type	-5 to 60°C	0.05 MPa
<b>A</b>	Main parts: Stainless steel (For water)	-5 to 60°C	0.05 MPa
<b>E</b>	Low cracking pressure	-5 to 60°C	0.01 MPa
<b>H</b>	High temperature	-5 to 80°C	0.05 MPa
<b>L</b>	Low temperature	-30 to 60°C	0.05 MPa

Note 1) A combination of H and L is not possible.

Note 2) Refer to "Specifications/Models" on page 790 for combinations of each option.

### Construction/Dimensions

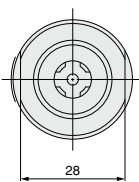
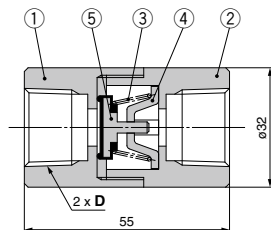

#### Symbol

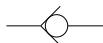

Part no.	D	Weight (g)
XTO-674-02□	Rc 1/4	280
XTO-674-03□	Rc 3/8	255
XTO-674-04□	Rc 1/2	225

### Component Parts

No.	Description		Material										
	Option symbol	Basic type	A	E	H	L	AE	AH	AL	EH	EL	AEH	AEL
1	Body A		Brass										
2	Body B		Brass										
3	Check valve spring		Stainless steel 304										
4	Stopper		Stainless steel 304										
5	Valve	Steel	Stainless steel 304	Steel			Stainless steel 303			Steel		Stainless steel 304	
	Bracket		Stainless steel 303									Stainless steel 303	
	Rubber lining		NBR		FKM	CR	NBR	FKM	CR	FKM	CR	FKM	CR