

Inch size Rotary One-touch Fittings Standard Type

KS Series

Applicable Tubing: Inch Size

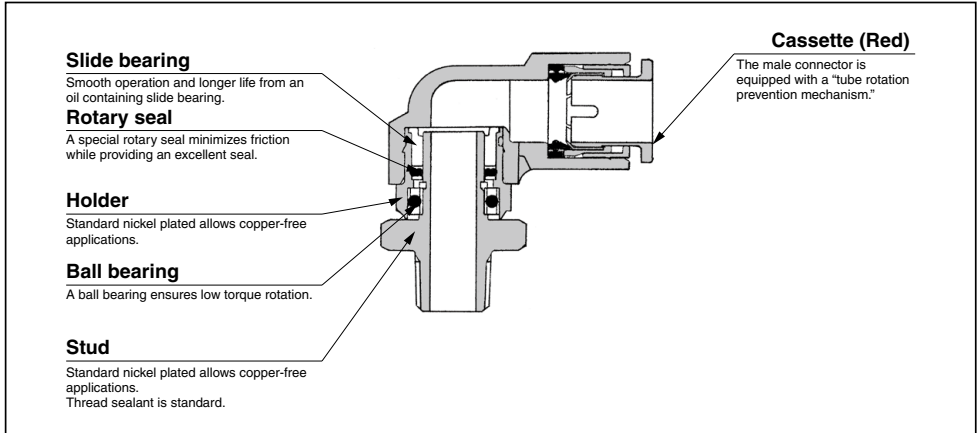

Low-torque rotation type rotary One-touch fittings

Applicable to use for oscillating and rotating sections in robots.

Brass parts are electroless nickel plated.

Sealant is standard.



Applicable Tubing

Tubing material	FEP, PFA, Nylon, Soft nylon, Polyurethane
Tubing O.D.	$\phi 5/32"$, $\phi 1/4"$, $\phi 5/16"$, $\phi 3/8"$

Specification

Fluid	Air
Operating pressure range ¹⁾	-100 kPa to 1 MPa
Proof pressure	3 MPa
Ambient and fluid temperature	-5 to 60°C (No freezing)
Thread	ANSI/ASME B1.20.1 (NPT thread) JIS B 0212 (UNF thread)
Seal on the threads (Standard)	With thread sealant
Brass parts surface treatment (Standard)	Electroless nickel plated

Note 1) Do not use the fittings with a leak tester or for vacuum retention because they are not guaranteed for zero leakage.

Also, when using in a vacuum, grease may enter the inside due to the nature of its construction.

Rotating Torque/Allowable Number of Rotations

Applicable tubing O.D.	$\phi 5/32"$	$\phi 1/4"$	$\phi 5/16"$	$\phi 3/8"$
Rotating torque (N·m) ²⁾	0.006	0.012	0.014	0.020
Allowable number of rotations (S ⁻¹) ³⁾	8.3	8.3	6.7	5



Note 2) Rotating torque under pressure 0.5 MPa

Note 3) Number of rotations per second

Principal Parts Material

Principal parts	KS Series
Body	PBT
Stud, Holder, Guide	Stainless steel 304, C3604 (With electroless nickel plated), PBT
Chuck, Retainer	Stainless steel 304
Collet, Release button, Retaining ring	Polycetal
O-ring, Packing	NBR
Rotary seal	NBR
Slide bearing	Oil-containing polycetal
Scraper	—
Ball bearing	Bearing steel
Gasket	Stainless steel 304, NBR

KS Series

Model	Connection thread	Applicable tubing O.D. (inch)			
		$\phi 5/32''$	$\phi 1/4''$	$\phi 5/16''$	$\phi 3/8''$
Male connector KSH 	10-32 UNF	●			
	NPT 1/8	●	●	●	
	NPT 1/4		●	●	●
	NPT 3/8				●
Male elbow KSL 	10-32 UNF	●			
	NPT 1/8	●	●	●	
	NPT 1/4		●	●	●
	NPT 3/8				●

⚠ Precautions

Be sure to read this before handling the products.
Refer to page 11 for safety instructions and pages 14 to 18 for fittings and tubing precautions.

⚠ Caution

- Implement the tube piping in such a way that lateral load should not be applied on the ball bearings at the rotating part, otherwise it may adversely affect the life expectancy.
 A flexible polyurethane tube is recommended when lateral load is applied.

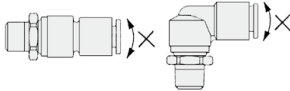

- Do not use in an environment where it will be exposed to water.
 Contact with water will cause outflow of the lubricating oil used in the ball bearings, and adversely affect rotating performance and equipment lifespan.
- Fluorine based grease is used on the rotating portions.

KS Series

Male Connector: KSH (Standard)

<UNF>



Applicable tubing O.D. (inch)	Connection thread UNF NPT	Model	H (Width across flats)	D1	D2	L	A *	M	Effective area (mm ²)		Weight (g)	
									Nylon	Urethane		
5/32	10-32 UNF	KSH03-32	8	10.4	12	36.5	33	16	2.5	4.0	9	
		KSH03-34S	12.7			37.6	34.5				14	
1/4	1/8	KSH07-34S		14.29	13.2	14	38.6	35.5	17	4	13.4	17
	1/4	KSH07-35S				42	36.5				23	
5/16	1/8	KSH09-34S		17.46	15.2	17	43.1	40	18.5	6	26.1	18.0
	1/4	KSH09-35S				46.5	41				29	
3/8	1/4	KSH11-35S		22.23	17.9	22	53.5	48	21	7	36.3	29.5
	3/8	KSH11-36S				53.9	48.5				63	

* Reference dimensions after NPT thread installation.

<UNF>

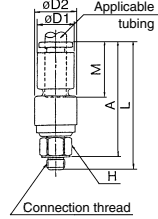

<NPT>

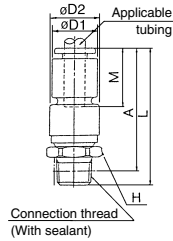

<NPT>



Male Elbow: KSL (Standard)

<UNF>



Applicable tubing O.D. (inch)	Connection thread UNF NPT	Model	H (Width across flats)	D1	D2	L1	L2	A *	M	Effective area (mm ²)		Weight (g)
										Nylon	Urethane	
5/32	10-32 UNF	KSL03-32	8	10.4	12	21	20.5	22	16	2.5	3.5	9
		KSL03-34S	12.7				21.1	23.5				14
1/4	1/8	KSL07-34S		14.29	13.2	14	23.5	22.1	17	4	8.6	17
	1/4	KSL07-35S					25.5	26.5			23	
5/16	1/8	KSL09-34S		17.46	15.2	17	26	25.6	18.5	6	21.6	14.9
	1/4	KSL09-35S					29	31			23	
3/8	1/4	KSL11-35S		22.23	17.9	22	31.5	33.5	21	7	30.5	25.0
	3/8	KSL11-36S					33.9	38			64	

* Reference dimensions after NPT thread installation.

<UNF>

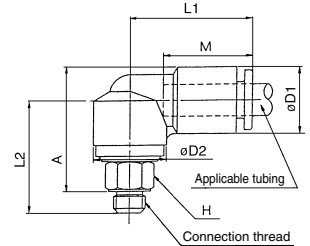

<NPT>

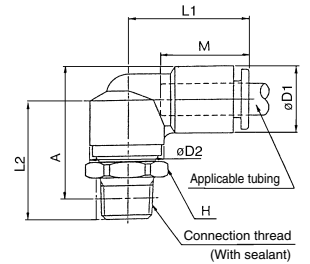

<NPT>



[Click here for applicable color caps.](#)