

Self-align Fittings H/DL/L/LL Series

Flared ridge ferrule

Prevents accidental loss of ferrule when inserting tubing into the fitting body.

Hardened ridge ferrule

Prevents breakage of ferrule when tightening nut.

Flared I.D.

Provides low flow resistance inside the fitting.

Wide variety of types and sizes

Ten types and five tube O.D.'s provide a wide range of fittings that will fit any application.



Cross Reference Table of the Inner Sleeve ^{Note 1)}

Polyurethane tubing		Inner sleeve	
O.D. x I.D.	Part no.	Part no.	Length
ø4 x ø2.5	TU0425	TJ-0425	18
ø6 x ø4	TU0604	TJ-0604	19
ø8 x ø5	TU0805	TJ-0805	20.5
ø10 x ø6.5	TU1065	TJ-1065	23
ø12 x ø8	TU1208	TJ-1208	24

* C2700 + Electroless nickel plated is used for the TJ series.

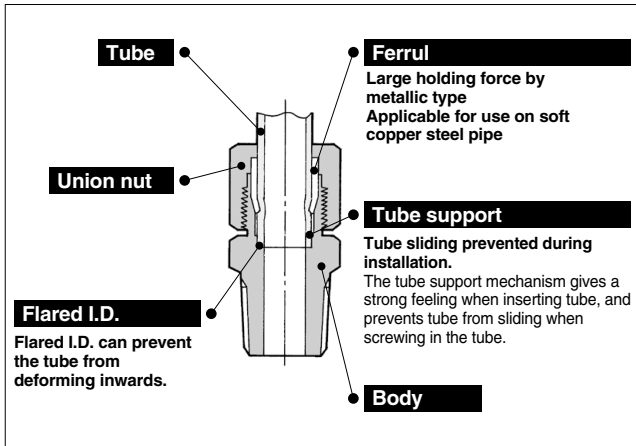

Specifications

Applicable tubing material	Nylon, Soft nylon Polyurethane (Mounting the inner sleeve) ^{Note 1)} Soft copper steel pipe (C1220T-0)	
Applicable tubing O.D.	ø4, ø6, ø8, ø10, ø12	
Maximum operating pressure ^{Note 2)}	1 MPa	
Proof pressure	10 MPa	
Fluid	Air, N ₂	
Ambient and fluid temperatures	-5 to 60°C (No freezing)	
Thread	Mounting section	JIS B 0203 (Taper thread for piping)
	Nut section	JIS B 0205 (Metric fine thread)
Seal on the threads ^{Note 3)}	None or with sealant	

Note 1) When using polyurethane tubing, install an inner sleeve.

Note 2) Check the operating pressure range and operating temperature range of the tubing.

Note 3) Male elbow, Male branch tee, Male run tee with sealant is manufactured upon receipt of order. Suffix "S" to the end of part number if w/ sealant is desired.

Made to Order

Symbol	Specifications
X2	Applicable to non-copper type (With electroless nickel plated)

Add -X2 at the end of the model number.

Ex.) H04-01-X2

Principal Parts Material

Body	C3604, C3771BE
Nut	C3604
Ferrul	C2700

H/DL/L/LL Series

Model

Male connector

H P. 319



Use to pipe in the same direction from female thread. Most general type.

Male run tee

DY P. 320



Use to branch line in the same direction from female thread and in 90° direction.

Male elbow

DL P. 319



Use to pipe at right angles to female thread. Most general type.

Bulkhead union

DE P. 320



Use to connect tubes through a panel.

Union tee

DT P. 319



Use to connect tubes in both 90° directions.

Bulkhead connector

DEF P. 320



Use to connect male thread and tube through a panel.

Female connector

DHF P. 319



Use to pipe from male thread such as pressure gauge.

Plug

DP P. 321



Use to plug unused fittings.

Male branch tee

DT P. 320



Use to branch line from female thread in both 90° directions.

Swivel elbow

L P. 321



Use to pipe at right angles to female thread. Swiveled at any direction.

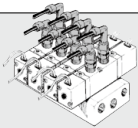

Swivel extended elbow

LL P. 321



Use to pipe at right angles to female thread. Swiveled at any direction. Solid piece moves fittings up from workpiece.

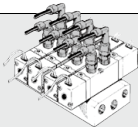

Male Connector: H

Applicable tubing O.D. (mm)	Connection threads R	Model	H1 (width across flats)	H2 (width across flats)	L	M	A*	Effective area (mm ²)	Weight (g)
4	1/8	H04-01	10	10	24.2	15	21.1	4	10
	1/4	H04-02	14	10	28.6				17
6	1/8	H06-01	10	12	24.2	16	23.1	11	12
	1/4	H06-02	14		28.6				19
	3/8	H06-03	17		30				31
8	1/8	H08-01	12	14	24.2	16	21.1	20	16
	1/4	H08-02	14		28.6				21
	3/8	H08-03	17		30				30
10	1/4	H10-02	14	17	28.6	17	23.1	34	28
	3/8	H10-03	17		30				37
	1/2	H10-04	22		33.2				53
12	1/4	H12-02	17	19	29.6	17	24.1	51	30
	3/8	H12-03	17		30				39
	1/2	H12-04	22		33.2				59

* Reference dimensions after R thread installation.

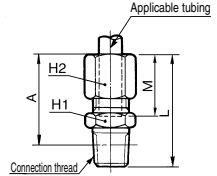

Male Elbow: DL

Applicable tubing O.D. (mm)	Connection threads R	Model	H1 (width across flats)	H2 (width across flats)	L1	L2	M	A*	Effective area (mm ²)	Weight (g)	
4	1/8	DL04-01	10	10	23.5	17	15	19.6	3.5	23	
	1/4	DL04-02								19	30
6	1/8	DL06-01	10	12	23.5	17	16	19.6	9	25	
	1/4	DL06-02								19	31
	3/8	DL06-03								14	26.5
8	1/8	DL08-01	12	14	24.5	18	16	22.6	19	32	
	1/4	DL08-02								21	38
	3/8	DL08-03								14	26.5
10	1/4	DL10-02	14	17	26.5	23	17	25.8	31	51	
	3/8	DL10-03								22	57
	1/2	DL10-04								17	28.5
12	1/4	DL12-02	17	19	28.5	25	17	29.6	43	76	
	3/8	DL12-03								26	85
	1/2	DL12-04								27	29.4

* Reference dimensions after R thread installation.

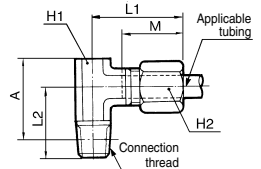

Union Tee: DT

Applicable tubing O.D. (mm)	Model	H1 (width across flats)	H2 (width across flats)	L	M	Effective area (mm ²)	Weight (g)
4	DT04-00	10	10	23.5	15	5.7	32
6	DT06-00	10	12	23.5	16	14	36
8	DT08-00	12	14	24.5	16	25	47
10	DT10-00	14	17	26.5	17	49	70
12	DT12-00	17	19	28.5	17	55	70

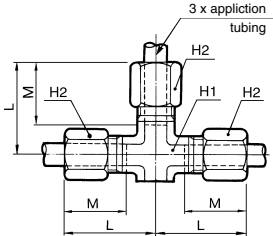

Female Connector: DHF

Applicable tubing O.D. (mm)	Connection threads Rc	Model	H1 (width across flats)	H2 (width across flats)	L1	L2	M	Effective area (mm ²)	Weight (g)
4	1/4	DHF04-02	17	10	30.3	16	15	4	27
	1/4	DHF06-02	17	10	30.8	16.5	16	11	28
6	3/8	DHF06-03	19	12	32.8	18.5	16	11	31
	1/4	DHF08-02	17	14	29.8	15.5	16	20	30
10	1/4	DHF10-02	17	17	30.8	16.5	17	34	37
12	1/4	DHF12-02	17	19	30.8	16.5	17	51	40

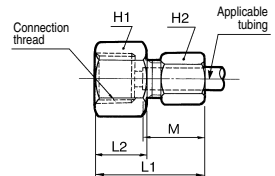

H/DL/L/LL Series

Male Branch Tee: DT

Applicable tubing O.D. (mm)	Connection threads R	Model	H1 (width across flats)	H2 (width across flats)	L1	L2	M	A*	Effective area (mm ²)	Weight (g)
4	1/8	DT04-01	10	10	23.5	17	15	19.6	5.7	33
	1/4	DT04-02				19				40
6	1/8	DT06-01	10	12	23.5	17	16	19.6	14	35
	1/4	DT06-02				19				44
	3/8	DT06-03	14		26.5	22		24.5		70
8	1/8	DT08-01	12	14	24.5	18	16	21.6	45	52
	1/4	DT08-02				21		22.6		55
	3/8	DT08-03	14		26.5	22		24.5		73
10	1/4	DT10-02	14	17	26.5	23	17	25.8	72	72
	3/8	DT10-03				22		24.5		78
	1/2	DT10-04	17		28.5	27		29.4		120
	3/8	DT12-03	17	19	28.5	26	17	29.6	55	106
12	3/8	DT12-03				27		30.3		111
	1/2	DT12-04				27		29.4		120

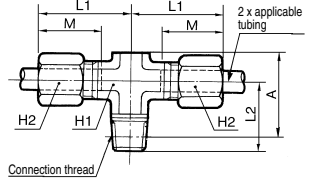

* Reference dimensions after R thread installation.

Male Run Tee: DY

Applicable tubing O.D. (mm)	Connection threads R	Model	H1 (width across flats)	H2 (width across flats)	L1	L2	M	A*	Effective area (mm ²)	Weight (g)
4	1/8	DY04-01	10	10	23.5	17	15	36.5	6.9	32
	1/4	DY04-02				19				40
6	1/8	DY06-01	10	12	23.5	17	16	36.5	16	36
	1/4	DY06-02				19		42.2		42
	3/8	DY06-03	14		26.5	22		42.2		66
8	1/8	DY08-01	12	14	24.5	18	16	38.5	44	44
	1/4	DY08-02				21		39.5		51
	3/8	DY08-03	14		26.5	22		42.2		69
10	1/4	DY10-02	14	17	26.5	23	17	43.5	70	70
	3/8	DY10-03				22		42.2		77
	1/2	DY10-04	17		28.5	27		47.3		116
	3/8	DY12-03	17	19	28.5	25	17	47.5	106	106
12	3/8	DY12-03				26	17	47.2	62	112
	1/2	DY12-04				27		47.3		119

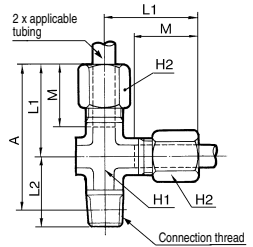

* Reference dimensions after R thread installation.

Bulkhead Union: DE

Applicable tubing O.D. (mm)	Model	H1 (width across flats)	H2 (width across flats)	L	M	Effective area (mm ²)	Mounting hole	Mounting plate thickness	Weight (g)
4	DE04-00	10	10	47.5	15	4	9	4 max.	29
6	DE06-00	12	12	50.5	16	11	11	4 max.	43
8	DE08-00	14	14	52.5	16	20	13	6 max.	62
10	DE10-00	17	17	55.5	17	34	15	7 max.	93
12	DE12-00	19	19	56.5	17	51	17	7 max.	112

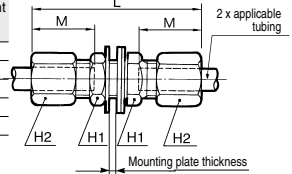

Bulkhead Connector: DEF

Applicable tubing O.D. (mm)	Connection threads Rc	Model	H1 (width across flats)	H2 (width across flats)	H3 (width across flats)	L1	L2	M	Effective area (mm ²)	Mounting hole	Mounting plate thickness	Weight (g)
6	1/4	DEF06-02	17	12	12	46.5	15	16	11	11	4 max.	48
8	3/8	DEF08-03	19	14	14	50.5	17	16	20	13	6 max.	66
10	3/8	DEF10-03	19	17	17	53.5	17	17	34	15	7 max.	89
12	3/8	DEF12-03	19	19	19	54.5	17	17	51	17	7 max.	104

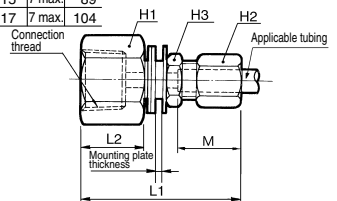

Plug: DP



Applicable fitting (mm)	Model	L	øD	Weight (g)
4	DP-04	8	5.6	0.2
6	DP-06		7.6	0.5
8	DP-08		9.6	0.8
10	DP-10		11.6	1.2
12	DP-12		13.6	1.6

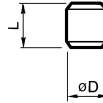

Swivel Elbow: L



Applicable tubing O.D. (mm)	Connection thread R	Model	H1 (width across flats)	H2 (width across flats)	H3 (width across flats)	H4 (width across flats)	L1	L2	M	A*	Effective area (mm ²)	Weight (g)
4	1/8	L04-01	10	10	14	10	21.8	30	15	32.7	3.5	33
	1/4	L04-02				14		34.4		34.7		40
6	1/8	L06-01	12	10	14	10	21.8	30	16	33.8	9	36
	1/4	L06-02				14		34.4		35.8		43
	3/8	L06-03				17		35.8		37.5		55
	1/2	L06-04				20		36.8		39.7		61
8	1/8	L08-01	14	12	17	12	23.3	31	16	36	19	46
	1/4	L08-02				14		35.4		38		52
	3/8	L08-03				17		36.8		39.7		61
	1/2	L08-04				20		38.4		40.7		76
10	1/8	L10-01	17	14	19	17	23.3	37.8	17	42.4	31	76
	1/4	L10-02				22		41		43.5		96
	3/8	L10-03				25		43.4		44.9		86
	1/2	L10-04				28		45.6		46.7		118
12	1/8	L12-01	19	17	22	17	24.3	39.8	17	45.6	43	94
	1/4	L12-02				22		43		46.7		118
	3/8	L12-03				25		45.6		47.7		129
	1/2	L12-04				28		47.7		48.7		141

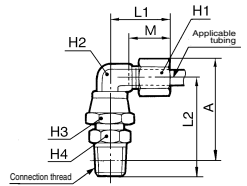

* Reference dimensions after R thread installation.

Swivel Extended Elbow: LL



Applicable tubing O.D. (mm)	Connection thread R	Model	H1 (width across flats)	H2 (width across flats)	H3 (width across flats)	H4 (width across flats)	L1	L2	M	A*	Effective area (mm ²)	Weight (g)
4	1/8	LL04-01	10	10	14	10	21.8	50	15	52.7	3.5	45
	1/4	LL04-02				14		54.4		54.7		53
6	1/8	LL06-01	12	10	14	10	21.8	51	16	54.8	9	47
	1/4	LL06-02				14		55.4		56.8		44
	3/8	LL06-03				17		56.8		58.5		66
	1/2	LL06-04				20		58.4		60.7		83
8	1/8	LL08-01	14	12	17	12	23.3	52	16	57	19	63
	1/4	LL08-02				14		56.4		59		68
	3/8	LL08-03				17		57.8		60.7		83
	1/2	LL08-04				20		59.4		62.7		98
10	1/8	LL10-01	17	14	19	17	23.3	59.8	17	64.4	31	98
	1/4	LL10-02				22		63		65.5		117
	3/8	LL10-03				25		65.4		67.8		121
	1/2	LL10-04				28		67.8		69.7		141
12	1/8	LL12-01	19	17	22	17	24.3	62.8	17	68.5	43	129
	1/4	LL12-02				22		66		69.7		141
	3/8	LL12-03				25		68.8		70.7		153
	1/2	LL12-04				28		70.7		71.7		165

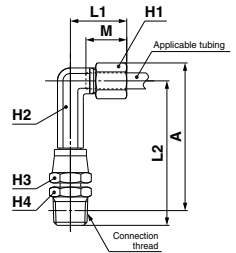

* Reference dimensions after R thread installation.

H/DL/L/LL Series

Swivel Type/Parts No.

Swivel type fitting parts lineup

The body of elbow connectors and extended elbow connectors are compatible with almost any fitting. (Except "L-04" and "LL-04" which are for the body of $\phi 6$ tube.) Swivel fittings, elbow (L) and (LL) constitute the combination with a male connector (H) and connector as shown in the diagram.

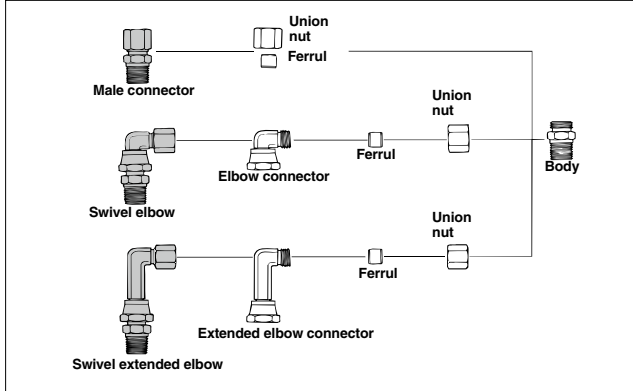

Note) How to install elbow fittings

After tightening by hand, tighten an additional 1/6 to 1/3 turn with a wrench.

Union Nut: N			Elbow Connector: L		Ferrul: S			Extended Elbow Connector: LL	
Part no.	Applicable tubing O.D.	Weight (g)	Part no.	Applicable tubing O.D.	Part no.	Applicable tubing O.D.	Weight (g)	Part no.	Applicable tubing O.D.
N-04	$\phi 4$	5	L-04	$\phi 4$	S-04	$\phi 4$	0.7	LL-04	$\phi 4$
N-06	$\phi 6$	7	L-06	$\phi 6$	S-06	$\phi 6$	1.1	LL-06	$\phi 6$
N-08	$\phi 8$	8	L-08	$\phi 8$	S-08	$\phi 8$	1.4	LL-08	$\phi 8$
N-10	$\phi 10$	13	L-10	$\phi 10$	S-10	$\phi 10$	1.7	LL-10	$\phi 10$
N-12	$\phi 12$	14	L-12	$\phi 12$	S-12	$\phi 12$	2.0	LL-12	$\phi 12$

⚠ Precautions

Be sure to read this before handling the products.
Refer to page 11 for safety instructions and pages 14 to 18 for fittings and tubing precautions.

Installation

⚠ Caution

1. Cut the tube perpendicular to the tube axis a little longer than the required length. (Use tube cutter TK-1, 2 or 3.)
2. Then, push the cut tube in until it comes to the flared edge, and tighten the nut by hand.
3. Furthermore, give the nut an additional 1.5 turns with a tightening tool. Leave no space between the screwed-in nut and the tube in-line with the tube axis. If tightened insufficiently, nut may be loosened and it may result in air leakage or may come off.
4. When using soft copper tube, first tighten the nut by hand and then give it an additional one turn with wrench. Use JIS H3300, equivalent to seamless tube C1220T-0, as soft copper tube. If using any other type, it may cause the air leakage or tube to come off.
5. Sleeve is not recyclable. Replace it every time piping is performed.