

Mechanically Jointed Rodless Cylinder with Protective Cover

MY1□W Series

ø16, ø20, ø25, ø32, ø40, ø50, ø63

Protective cover offers excellent dust and water resistance



Series	Guide type	Cover	Bore size (mm)						Option
			16	20	25	32	40	50	
MY1MW	Slide bearing guide	With protective cover	●	●	●	●	●	●	<ul style="list-style-type: none"> • Centralized piping • Stroke adjusting unit • Side support
MY1MWK		With protective cover With side seal	●	●	●	●	●		
MY1CW	Cam follower guide	With protective cover	●	●	●	●	●	●	
MY1CWK		With protective cover With side seal	●	●	●	●	●		

MY1□W Series

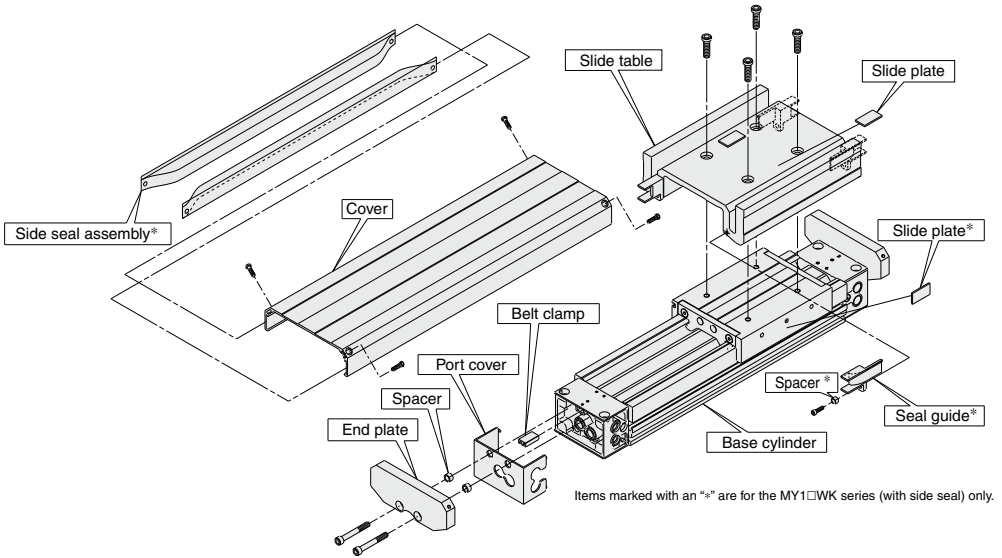

1 Dustproof and water resistant features are improved for using in locations where the cylinder is exposed to powder dust and water drop or splash.

2 Side seals provide greater lateral dustproof and water resistance.

3 The cover in no way interferes with the installation of base cylinder option.

4 Cover units and side seal units can be installed on the already current MY1M/MY1C series.

5 Protective cover only minimally adds to overall length.

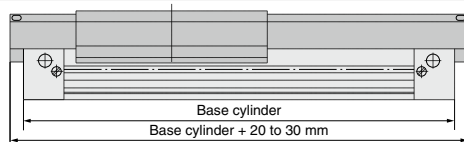

6 Water-resistant solid state switches can be mounted.

MY1□W Series Model Selection 1

This section illustrates the standard model selection procedure to help you choose the most suitable cylinders from the MY1MW/MY1CW series for your application needs.

Standards for Tentative Model Selection

Cylinder model	Guide type	Standards for guide selection	Graphs for related allowable values
MY1MW	Slide bearing guide type	Slide table ⁽²⁾ accuracy approx. ± 0.12 mm	P.1060
MY1CW	Cam follower guide type	Slide table ⁽²⁾ accuracy approx. ± 0.05 mm	P.1061

Note 1) These accuracy values for each guide should be used only as a guide during selection. Please contact SMC when guaranteed accuracy for MY1CW is required.

Note 2) "Accuracy" here means displacement of the slide table (at stroke end) when 50% of the allowable moment shown in the catalog is applied. (reference value).

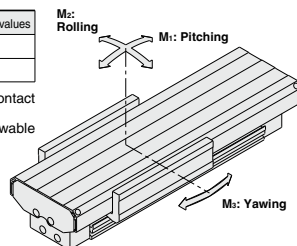

Selection Flow Chart

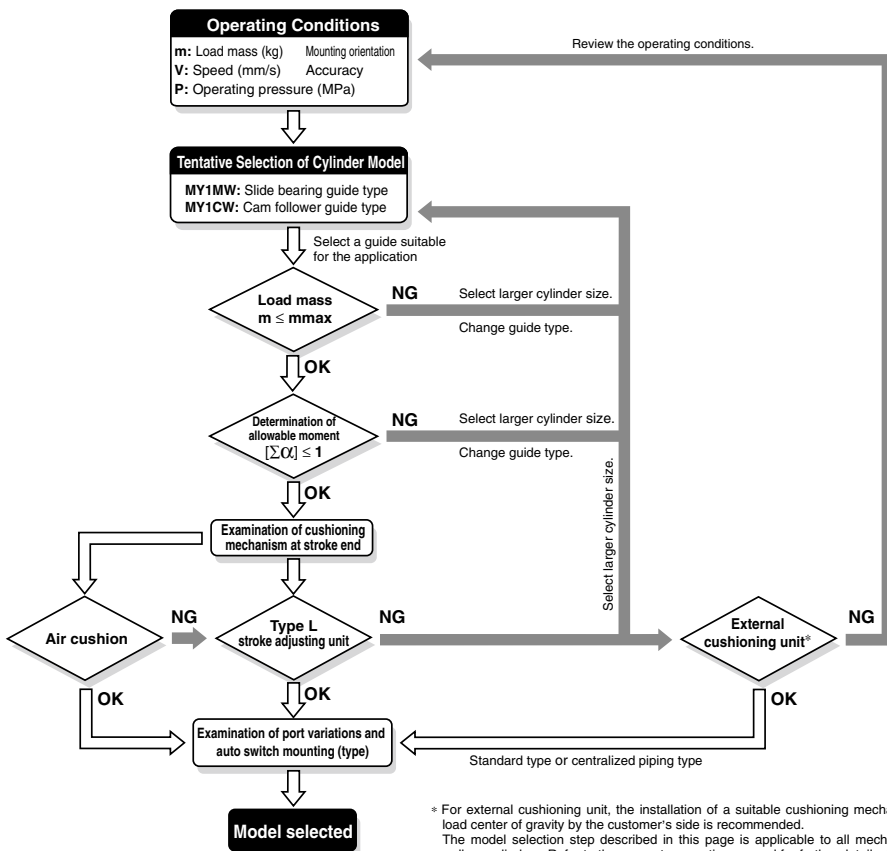

* For external cushioning unit, the installation of a suitable cushioning mechanism near the load center of gravity by the customer's side is recommended. The model selection step described in this page is applicable to all mechanically jointed rodless cylinders. Refer to the separate operation manual for further details. If you have any questions, please contact SMC.

Types of Moment Applied to Rodless Cylinders

Multiple moments may be generated depending on the mounting orientation, load, and position of the center of gravity.

Coordinates and Moments

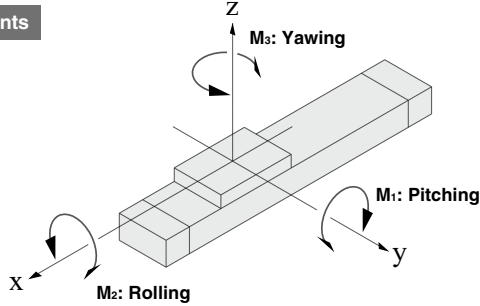

Static Moment

Horizontal mounting

Ceiling mounting

Wall mounting

Vertical mounting

g: Gravitational acceleration

Mounting orientation	Horizontal mounting	Ceiling mounting	Wall mounting	Vertical mounting
Static load (m)	m_1	m_2	m_3	m_4 (Note)
Static moment	$M_1: m_1 \times g \times X$	$M_2: m_2 \times g \times X$	—	$m_4 \times g \times Z$
	$M_2: m_1 \times g \times Y$	$M_3: m_2 \times g \times Y$	$m_3 \times g \times Z$	—
	—	—	$m_3 \times g \times X$	$m_4 \times g \times Y$

Note) "m₄" is a mass movable by thrust. Use 0.3 to 0.7 times the thrust (varies depending on the operating speed) as a guide for actual use.

Dynamic Moment

Mounting orientation	Horizontal mounting	Ceiling mounting	Wall mounting	Vertical mounting
Dynamic load F_E	$\frac{1.4}{100} \times v_a \times m_n \times g$			
Dynamic moment	M_{1E}	$\frac{1}{3} \times F_E \times Z$		
	M_{2E}	Dynamic moment M_{2E} is not generated.		
	M_{3E}	$\frac{1}{3} \times F_E \times Y$		

Note) Regardless of the mounting orientation, dynamic moment is calculated using the formulas above.

g: Gravitational acceleration, v_a : Average speed

Maximum Allowable Moment/Maximum Load Mass

Model	Bore size (mm)	Maximum allowable moment (N·m)			Maximum load mass (kg)		
		M1	M2	M3	m1	m2	m3
MY1MW	16	6.0	3.0	1.0	18	7	2.1
	20	10	5.2	1.7	26	10.4	3
	25	15	9.0	2.4	38	15	4.5
	32	30	15	5.0	57	23	6.6
	40	59	24	8.0	84	33	10
	50	115	38	15	120	48	14
MY1CW	63	140	60	19	180	72	21
	16	6.0	3.0	2.0	18	7	2.1
	20	10	5.0	3.0	25	10	3
	25	15	8.5	5.0	35	14	4.2
	32	30	14	10	49	21	6
	40	60	23	20	68	30	8.2
50	115	35	35	93	42	11.5	
63	150	50	50	130	60	16	

The above values are the maximum allowable values for moment and load. Refer to each graph regarding the maximum allowable moment and maximum allowable load for a particular piston speed.

Caution on Design

If the product is operated with a guide load factor which exceeds the standard value, malfunction may occur due to damage to the cam follower and bearings. Therefore, be sure to confirm that the guide load factor is 1 or less.

Load mass (kg)

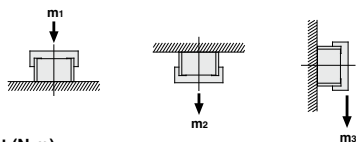

Caution

The cylinder should be mounted in m1 orientation if maximum dustproofing is required.

Moment (N·m)

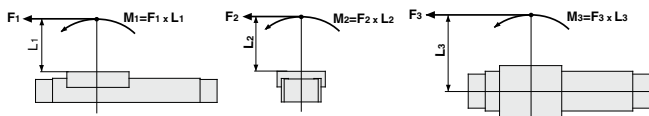

<Calculation of guide load factor>

1. Three factors must be considered when computing calculations for selection: (1) Maximum load mass, (2) Static moment, (3) Dynamic moment (at the time of impact with stopper).

* To evaluate, use \bar{v}_a (average speed) for (1) and (2), and v (collision speed $v = 1.4 \bar{v}_a$) for (3). Calculate m_{max} for (1) from the maximum allowable load graph ($m_1, m_2,$ and m_3), and M_{max} for (2) and (3) from the maximum allowable moment graph ($M_1, M_2,$ and M_3).

$$\text{Sum of guide load factors } \Sigma \alpha = \frac{\text{Load mass [m]}}{\text{Maximum allowable load [mmax]}} + \frac{\text{Static moment [M] (Note 1)}}{\text{Allowable static moment [Mmax]}} + \frac{\text{Dynamic moment [ME] (Note 2)}}{\text{Allowable dynamic moment [Memax]}} \leq 1$$

Note 1) Moment caused by the load, etc., with cylinder in resting condition.

Note 2) Moment caused by the impact load equivalent at the stroke end (at the time of impact with stopper).

Note 3) Depending on the shape of the workpiece, multiple moments may occur. When this happens, the sum of the load factors ($\Sigma \alpha$) is the total of all such moments.

2. Reference formula [Dynamic moment at impact]

Use the following formulae to calculate dynamic moment when taking stopper impact into consideration.

- m: Load mass (kg)
- F: Load (N)
- F_E: Load equivalent to impact (at impact with stopper) (N)
- \bar{v}_a : Average speed (mm/s)
- M: Static moment (N·m)
- v : Collision speed (mm/s)
- L: Distance to the load's center of gravity (m)
- M_E: Dynamic moment (N·m)
- g: Gravitational acceleration (9.8 m/s²)

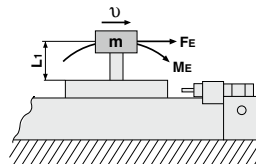

$$v = 1.4 \bar{v}_a \text{ (mm/s)} \quad F_E = \frac{1.4}{100} \bar{v}_a \cdot g \cdot m \text{ (Note 4)}$$

$$\therefore M_E = \frac{1}{3} F_E \cdot L = 0.05 \bar{v}_a m L \text{ (N·m) (Note 5)}$$

Note 4) $\frac{1.4}{100} \bar{v}_a$ is a dimensionless coefficient for calculating impact force.

Note 5) Average load coefficient ($= \frac{1}{3}$): This coefficient is for averaging the maximum load moment at the time of stopper impact according to service life calculations.

3. For detailed selection procedures, refer to pages 1064 and 1065.

Maximum Allowable Moment/Maximum Load Mass

Maximum Allowable Moment: Select the moment from within the range of operating limits shown in the graphs. Note that the maximum allowable load value may sometimes be exceeded even within the operating limits shown in the graphs. Therefore, also check the allowable load for the selected conditions.

MY1MW/M₁

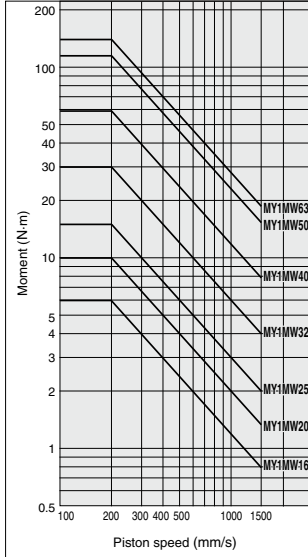

MY1MW/M₂

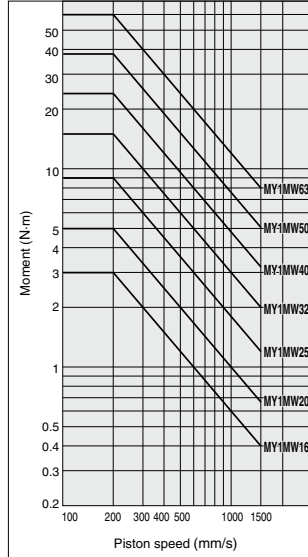

MY1MW/M₃

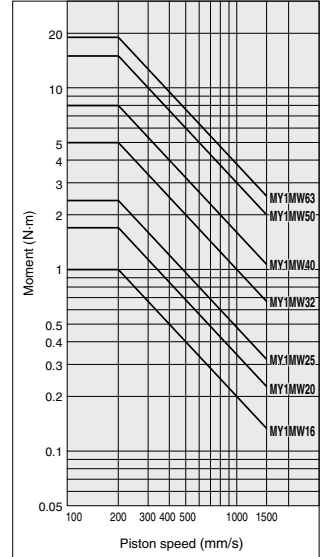

Maximum Load Mass: Select the load from within the range of limits shown in the graphs. Note that the maximum allowable moment value may sometimes be exceeded even within the operating limits shown in the graphs. Therefore, also check the allowable moment for the selected conditions.

MY1MW/m₁

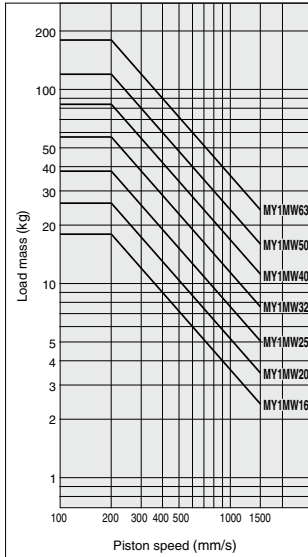

MY1MW/m₂

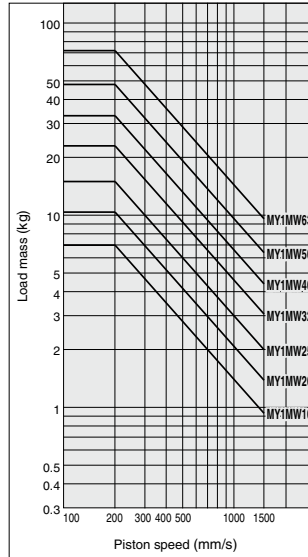

MY1MW/m₃

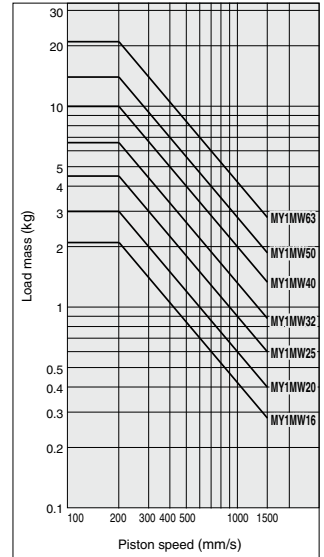

Maximum Allowable Moment: Select the moment from within the range of operating limits shown in the graphs. Note that the maximum allowable load value may sometimes be exceeded even within the operating limits shown in the graphs. Therefore, also check the allowable load for the selected conditions.

MY1CW/M1

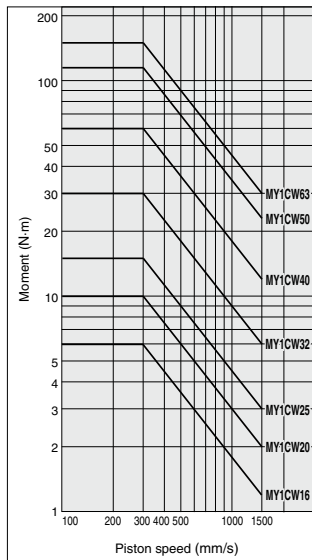

MY1CW/M2

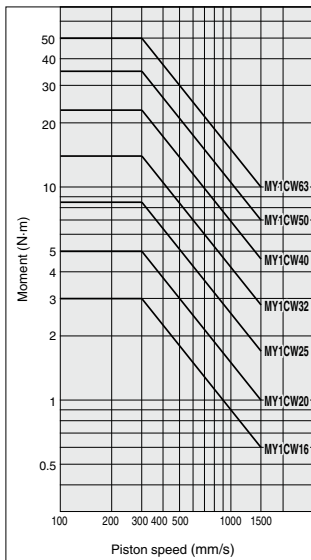

MY1CW/M3

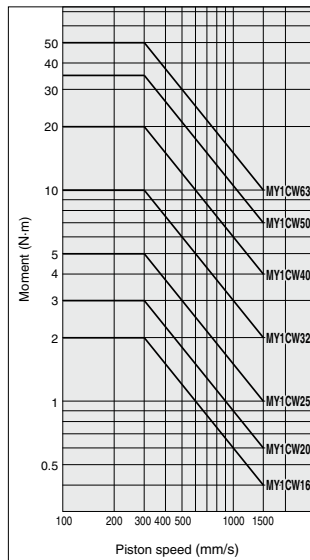

Maximum Load Mass: Select the load from within the range of limits shown in the graphs. Note that the maximum allowable moment value may sometimes be exceeded even within the operating limits shown in the graphs. Therefore, also check the allowable moment for the selected conditions.

MY1CW/m1

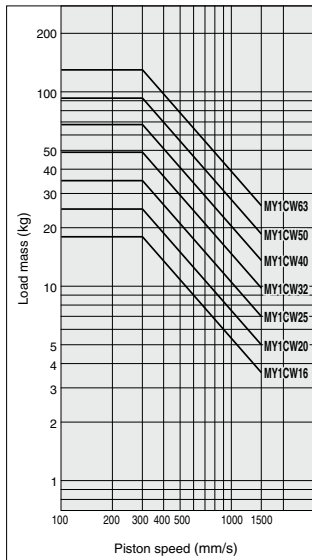

MY1CW/m2

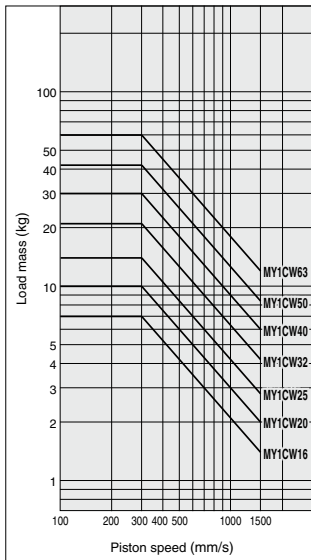

MY1CW/m3

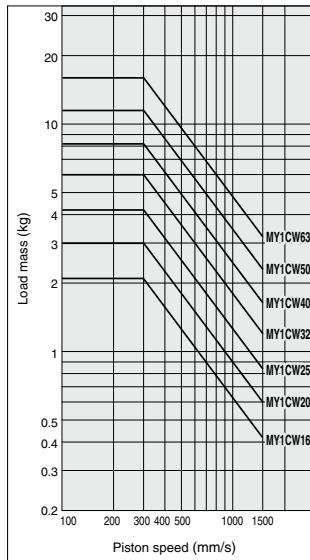

Cushion Capacity

Cushion Selection

<Air cushion>

Air cushions are a standard feature on mechanically jointed rodless cylinders.

The air cushion mechanism is incorporated to prevent excessive impact of the piston at the stroke end during high speed operation. The purpose of air cushion, thus, is not to decelerate the piston near the stroke end.

The ranges of load and speed that air cushions can absorb are within the air cushion limit lines shown in the graphs.

<Stroke adjusting unit with shock absorber>

Use this unit when operating with a load or speed exceeding the air cushion limit line, or when cushioning is required outside of the effective air cushion stroke range due to stroke adjustment.

L unit

Use this unit when the cylinder stroke is outside of the effective air cushion range even if the load and speed are within the air cushion limit line, or when the cylinder is operated in a load and speed range above the air cushion limit line or below the L unit limit line.

⚠ Caution

1. Refer to the figure below when using the adjusting bolt to perform stroke adjustment.

When the effective stroke of the shock absorber decreases as a result of stroke adjustment, the absorption capacity decreases dramatically. Secure the adjusting bolt at the position where it protrudes approximately 0.5 mm from the shock absorber.

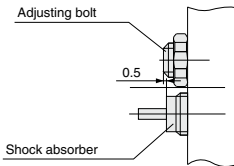

2. Do not use a shock absorber together with air cushion.

Air Cushion Stroke

(mm)

Bore size (mm)	Cushion stroke
16	12
20	15
25	15
32	19
40	24
50	30
63	37

Absorption Capacity of Air Cushion and Stroke Adjusting Units

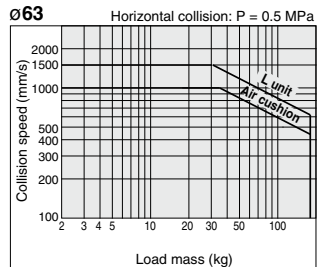
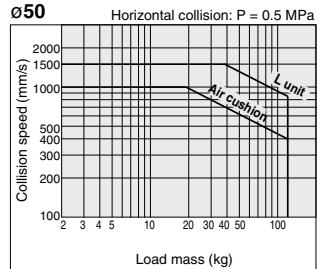
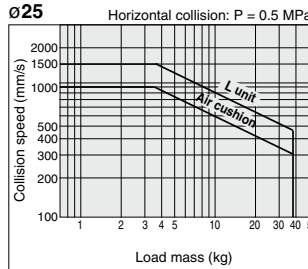
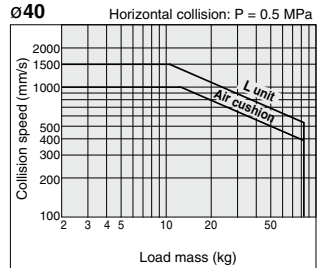
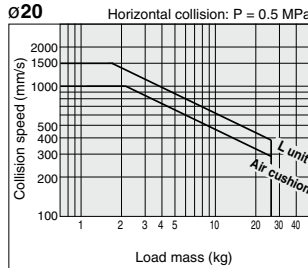
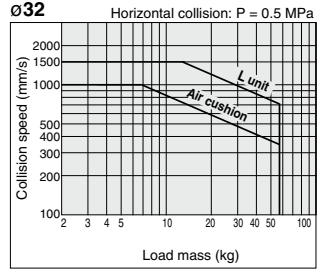
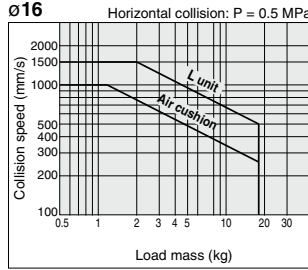



Tightening Torque for Stroke Adjusting Unit Holding Bolts (N·m)

Bore size (mm)	Unit	Tightening torque
16	A	0.7
	L	
20	A	1.8
	L	
25	A	3.5
	L	
32	A	5.8
	L	
40	A	13.8
	L	
50	A	13.8
	L	
63	A	27.5
	L	

Tightening Torque for Stroke Adjusting Unit Lock Plate Holding Bolts (N·m)

Bore size (mm)	Unit	Tightening torque
25	L	1.2
32	L	3.3
40	L	3.3

Calculation of Absorbed Energy for Stroke Adjusting Unit with Shock Absorber (N·m)

Type of impact	Horizontal collision	Vertical (Downward)	Vertical (Upward)
			
Kinetic energy E_1	$\frac{1}{2} m \cdot v^2$		
Thrust energy E_2	F·s	F·s + m·g·s	F·s - m·g·s
Absorbed energy E	$E_1 + E_2$		

Symbol

v: Speed of impact object (m/s)

m: Mass of impact object (kg)

F: Cylinder thrust (N)

g: Gravitational acceleration (9.8 m/s²)

s: Shock absorber stroke (m)

Note) The speed of the impact object is measured at the moment of impact with the shock absorber.

⚠ Precautions

Be sure to read this before handling the products. Refer to page 8 for safety instructions and pages 9 to 18 for actuator and auto switch precautions.

⚠ Caution

Use caution not to get your hands caught in the unit.

- When using a product with stroke adjusting unit, the space between the slide table (slider) and the stroke adjusting unit becomes narrow at the stroke end, causing a danger of hands getting caught. When operating with the protective cover removed (in the case of installation, etc.), be careful not to get your hands caught in the unit.

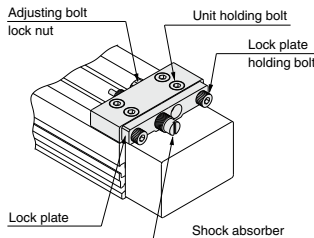
<Fastening of unit>

The unit can be secured by evenly tightening the four unit holding bolts.

⚠ Caution

Do not operate with the stroke adjusting unit fixed in an intermediate position.

When the stroke adjusting unit is fixed in an intermediate position, slippage can occur depending on the amount of energy released at the time of an impact. In such cases, as a stroke adjustment unit with the spacer for intermediate securing is available, it is recommended to use it.

For other lengths, please consult with SMC (Refer to the "Tightening Torque for Stroke Adjusting Unit Holding Bolts" values in the chart at the upper left corner of this page.)

<Stroke adjustment with adjusting bolt>

Loosen the adjusting bolt lock nut, and adjust the stroke from the lock plate side using a hexagon wrench. Retighten the lock nut.

<Stroke adjustment with shock absorber>

Loosen the two lock plate holding bolts, turn the shock absorber and adjust the stroke. Then, uniformly tighten the lock plate holding bolts to secure the shock absorber.

Avoid excessive tightening of the holding bolts (except for ø16, ø20, ø50, and ø63). (Refer to "Tightening Torque for Stroke Adjusting Unit Lock Plate Holding Bolts" above left.)

Note)

Although the lock plate may slightly bend due to tightening of the lock plate holding bolt, this does not affect the shock absorber and locking function.

MY1□W Series Model Selection 2

This section illustrates the standard model selection procedure using the actual operating conditions as one of the examples.

Calculation of Guide Load Factor

1 Operating Conditions

CylinderMY1MW40-500

Average operating speed v_a 200 mm/s

Mounting orientationHorizontal mounting

Wd: Workpiece (500 g)

Wc: MHL2-16D1(795 g)

Wa: Connection plate $t = 10$ (880 g)

MY1MW40-500

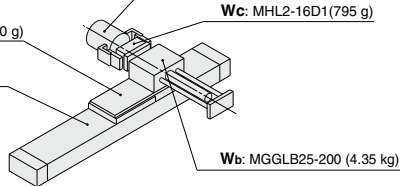

Mounting Orientation

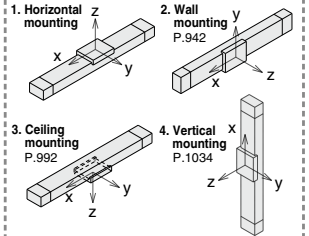

For actual examples of calculation for each orientation, refer to the pages above.

2 Load Blocking

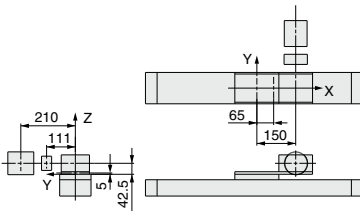

Mass and Center of Gravity for Each Workpiece

Workpiece no. W _n	Mass m _n	Center of gravity		
		X-axis X _n	Y-axis Y _n	Z-axis Z _n
Wa	0.88 kg	65 mm	0 mm	5 mm
Wb	4.35 kg	150 mm	0 mm	42.5 mm
Wc	0.795 kg	150 mm	111 mm	42.5 mm
Wd	0.5 kg	150 mm	210 mm	42.5 mm

n = a, b, c, d

3 Composite Center of Gravity Calculation

$$m_1 = \sum m_n$$

$$= 0.88 + 4.35 + 0.795 + 0.5 = \mathbf{6.525 \text{ kg}}$$

$$X = \frac{1}{m_1} \times \sum (m_n \times x_n)$$

$$= \frac{1}{6.525} (0.88 \times 65 + 4.35 \times 150 + 0.795 \times 150 + 0.5 \times 150) = \mathbf{138.5 \text{ mm}}$$

$$Y = \frac{1}{m_1} \times \sum (m_n \times y_n)$$

$$= \frac{1}{6.525} (0.88 \times 0 + 4.35 \times 0 + 0.795 \times 111 + 0.5 \times 210) = \mathbf{29.6 \text{ mm}}$$

$$Z = \frac{1}{m_1} \times \sum (m_n \times z_n)$$

$$= \frac{1}{6.525} (0.88 \times 5 + 4.35 \times 42.5 + 0.795 \times 42.5 + 0.5 \times 42.5) = \mathbf{37.4 \text{ mm}}$$

4 Calculation of Load Factor for Static Load

m₁: Mass

m₁.max (from 1 of graph MY1MW/m₁) = 84 (kg)

Load factor $\alpha_1 = m_1/m_{1.\text{max}} = 6.525/84 = \mathbf{0.08}$

M₁: Moment

M₁.max (from (2) of graph MY1MW/M₁) = 59 (N-m)

M₁ = m₁ × g × X = 6.525 × 9.8 × 138.5 × 10⁻³ = 8.86 (N-m)

Load factor $\alpha_2 = M_1/M_{1.\text{max}} = 8.86/59 = \mathbf{0.15}$

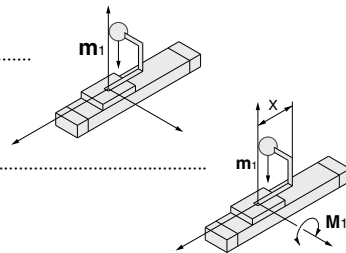

Calculation of Guide Load Factor

M₂: Moment

M_{2max} (from 3 of graph MY1MW: **M₂**) = 24 (N·m)

M₃ = **m₁** × **g** × **Y** = 6.525 × 9.8 × 29.6 × 10⁻³ = 1.89 (N·m)

Load factor **α₃** = **M₂**/**M_{2max}** = 1.89/24 = **0.08**

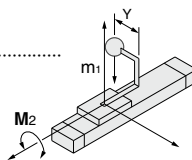

5 Calculation of Load Factor for Dynamic Moment

Equivalent load F_E at impact

$$F_E = \frac{1.4}{100} \times U_a \times g \times m = \frac{1.4}{100} \times 200 \times 9.8 \times 6.525 = 179.1 \text{ (N)}$$

M_{1E}: Moment

M_{1Emax} (from 4 of graph MY1MW: **M₁** where 1.4U_a = 280 mm/s) = 42.1 (N·m)

$$M_{1E} = \frac{1}{3} \times F_E \times Z = \frac{1}{3} \times 179.1 \times 37.4 \times 10^{-3} = 2.23 \text{ (N·m)}$$

Load factor **α₄** = **M_{1E}**/**M_{1Emax}** = 2.23/42.1 = **0.05**

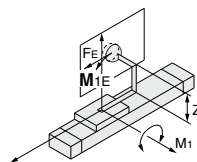

M_{3E}: Moment

M_{3Emax} (from 5 of graph MY1MW: **M₃** where 1.4U_a = 280 mm/s) = 5.7 (N·m)

$$M_{3E} = \frac{1}{3} \times F_E \times Y = \frac{1}{3} \times 179.1 \times 29.6 \times 10^{-3} = 1.77 \text{ (N·m)}$$

Load factor **α₅** = **M_{3E}**/**M_{3Emax}** = 1.77/5.7 = **0.31**

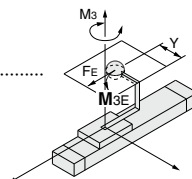

6 Sum and Examination of Guide Load Factors

$$\sum \alpha = \alpha_1 + \alpha_2 + \alpha_3 + \alpha_4 + \alpha_5 = 0.67 \leq 1$$

The above calculation is within the allowable value, and therefore the selected model can be used.

Select a shock absorber separately.

In an actual calculation, when the total sum of guide load factors $\sum \alpha$ in the formula above is more than 1, consider either decreasing the speed, increasing the bore size, or changing the product series. This calculation can be easily made using the "SMC Pneumatics CAD System".

Load Mass

MY1MW/m₁

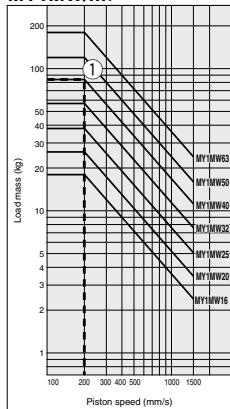

Allowable Moment

MY1MW/M₁

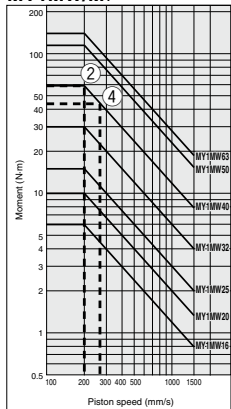

MY1MW/M₂

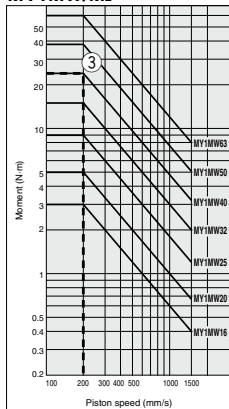

MY1MW/M₃

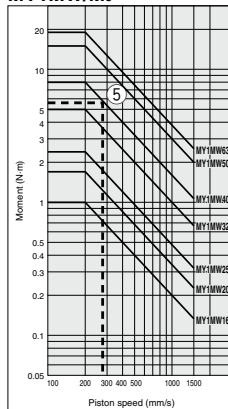

Mechanically Jointed Rodless Cylinder with Protective Cover Slide Bearing Guide Type, Cam Follower Guide Type

MY1□W Series

ø16, ø20, ø25, ø32, ø40, ø50, ø63

How to Order

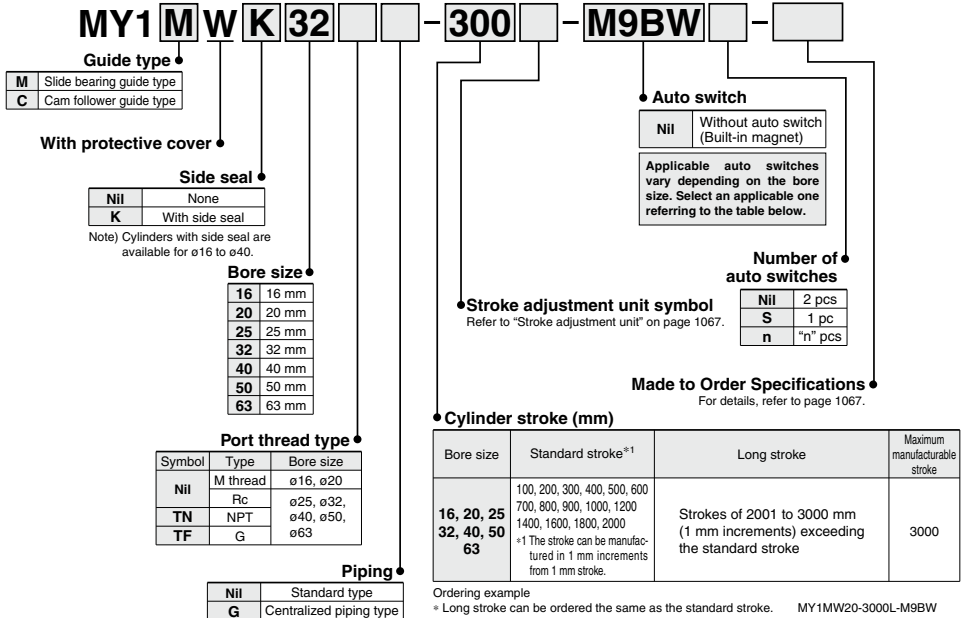

Ordering example

* Long stroke can be ordered the same as the standard stroke. MY1M20-3000L-M9BW

Note) Please be advised that with stroke 49 or less, there are cases where auto switch mounting is not possible and the performance of the air cushion may decline.

Applicable Auto Switches

Refer to pages 1289 to 1383 for further information on auto switches.

Type	Special function	Electrical entry	Indicator light	Wiring (Output)	Load voltage		Auto switch model						Lead wire length (m)				Pre-wired connector	Applicable load
					DC	AC	Perpendicular			In-line			0.5 (Nil)	1 (M)	3 (L)	5 (Z)		
							ø16, ø20	ø25 to ø40	ø50, ø63	ø16, ø20	ø25 to ø63	ø16, ø20						
Solid state auto switch	Diagnostic indication (2-color indicator)	Grommet	Yes	3-wire (NPN)	24 V	5 V, 12 V	—	M9NV	—	M9N	●	●	●	○	○	IC circuit	Relay, PLC	
								3-wire (PNP)	—	M9PV	—	M9P	●	●	●			○
				2-wire	12 V	—	M9BV	—	M9B	●	●	●	○					
				3-wire (NPN)	5 V, 12 V	—	M9NVV	—	M9NW	●	●	●	○					
				3-wire (PNP)	—	—	M9PVV	—	M9PW	●	●	●	○					
				2-wire	12 V	—	M9BVV	—	M9BV	●	●	●	○					
	Water resistant (2-color indicator)	Grommet	No	2-wire (NPN equivalent)	24 V	12 V	100 V	—	M9NAV*1	—	M9NA*1	○	○	○	○	IC circuit	Relay, PLC	
									3-wire (NPN)	—	M9PA*1	○	○	○	○			
									3-wire (PNP)	—	M9PAV*1	○	○	○	○			
									2-wire	12 V	—	M9BAV*1	—	M9BA*1	○			○
Reed auto switch	Grommet	Yes	2-wire (NPN equivalent)	24 V	12 V	100 V	100 V or less	A96	Z76	●	—	●	—	—	IC circuit	—		
								A93	Z73*2	●	●	●	●	—			—	
								A90	Z80	●	—	●	—	—			—	

*1 Water resistant type auto switches can be mounted on the above models, but in such case SMC cannot guarantee water resistance.

* Lead wire length symbols: 0.5 m.....Nil (Example) M9NV

1 m.....M (Example) M9NVM

3 m.....L (Example) M9NVL

5 m.....Z (Example) M9NVZ

* Solid state auto switches marked with "○" are produced upon receipt of order.

* Separate switch spacers (BMG2-012) are required to retrofit auto switches (M9 type) on cylinders ø25 to ø63.

*2 1 m type lead wire is only applicable to D-A93.

* Refer to page 1076 for details on other applicable auto switches than listed above.

* For details about auto switches with pre-wired connector, refer to pages 1358 and 1359.

* Auto switches are shipped together (not assembled). (Refer to pages 1075 to 1077 for the details of auto switch mounting.)

Mechanically Jointed Rodless Cylinder With Protective Cover **MY1□W Series**

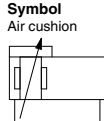
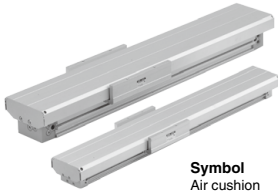

Made to Order Specifications
Click here for details

Symbol	Specifications
-XB22	Shock absorber soft type RJ series type
-XC67	NBR rubber lining in dust seal band

Specifications

Bore size (mm)	16	20	25	32	40	50	63
Fluid	Air						
Action	Double acting						
Operating pressure range	MY1MW 0.2 to 0.8 MPa					0.15 to 0.8 MPa	
	MY1CW 0.15 to 0.8 MPa					0.1 to 0.8 MPa	
Proof pressure	1.2 MPa						
Ambient and fluid temperature	5 to 60°C						
Cushion	Air cushion						
Lubrication	Non-lube						
Stroke length tolerance	1000 or less ^{+1.0} / _{-0.6}		2700 or less ^{+1.0} / _{-0.6} , 2701 to 3000 ^{+2.0} / _{-0.6}				
Piping port size	Front/Side port M5 x 0.8	Rc 1/8		Rc 1/4		Rc 3/8	
	Bottom port ø4	ø6		ø8		ø10	

Piston Speed

Bore size (mm)	16 to 63	
Without stroke adjustment unit	100 to 1000 mm/s	
Stroke adjustment unit	A unit	100 to 1000 mm/s ⁽¹⁾
	L unit	100 to 1500 mm/s ⁽²⁾

Note 1) Be aware that when the stroke adjustment range is increased by manipulating the adjustment bolt, the air cushion capacity decreases. Also, when exceeding the air cushion stroke ranges on page 1062, the piston speed should be 100 to 200 mm per second.

Note 2) The piston speed is 100 to 1000 mm/s for centralized piping.

Note 3) Use at a speed within the absorption capacity range. Refer to page 1062.

Stroke Adjustment Unit Specifications

Bore size (mm)		16		20		25		32		40		50		63	
Unit symbol		A	L	A	L	A	L	A	L	A	L	A	L	A	L
Configuration Shock absorber model	Without spacer	With adjustment bolt	RB 0806 + with adjustment bolt	With adjustment bolt	RB 0806 + with adjustment bolt	With adjustment bolt	RB 1007 + with adjustment bolt	With adjustment bolt	RB 1412 + with adjustment bolt	With adjustment bolt	RB 1412 + with adjustment bolt	With adjustment bolt	RB 2015 + with adjustment bolt	With adjustment bolt	RB 2015 + with adjustment bolt
	With short spacer	-5.6 to -11.2	-6 to -12	-11.5 to -23	-12 to -24	-16 to -32	-20 to -40	-25 to -50							
	With long spacer	-11.2 to -16.8	-12 to -18	-23 to -34.5	-24 to -36	-32 to -48	-40 to -60	-50 to -75							
Stroke adjustment range by intermediate fixing spacer (mm)	Without spacer	0 to -5.6	0 to -6	0 to -11.5	0 to -12	0 to -16	0 to -20	0 to -25							
	With short spacer	-5.6 to -11.2	-6 to -12	-11.5 to -23	-12 to -24	-16 to -32	-20 to -40	-25 to -50							
	With long spacer	-11.2 to -16.8	-12 to -18	-23 to -34.5	-24 to -36	-32 to -48	-40 to -60	-50 to -75							

* Stroke adjustment range is applicable for one side when mounted on a cylinder.

Stroke Adjustment Unit Symbol

		Right side stroke adjustment unit							
		Without unit	A: With adjustment bolt				L: With low load shock absorber + Adjustment bolt		
Left side stroke adjustment unit	Without unit	Nil	SA	SA6	SA7	SL	SL6	SL7	
		A: With adjustment bolt	AS	A	AA6	AA7	AL	AL6	AL7
	L: With low load shock absorber + Adjustment bolt	With short spacer	A6S	A6A	A6	A6A7	A6L	A6L6	A6L7
		With long spacer	A7S	A7A	A7A6	A7	A7L	A7L6	A7L7
		With short spacer	LS	LA	LA6	LA7	L	LL6	LL7
With long spacer	L6S	L6A	L6A6	L6A7	L6L	L6L6	L6L7		
With long spacer	L7S	L7A	L7A6	L7A7	L7L	L7L6	L7		

* Spacers are used to fix the stroke adjustment unit at an intermediate stroke position.

Stroke adjustment unit mounting diagram

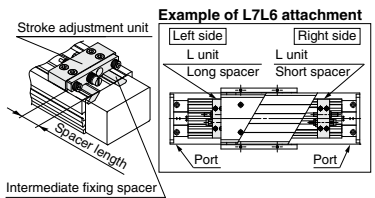

Intermediate fixing spacer

Shock Absorbers for L Unit

Type	Stroke adjustment unit	Bore size (mm)						
		16	20	25	32	40	50	63
Standard (Shock absorber/RB series)	L	RB0806	RB1007	RB1412	RB2015			
Shock absorber/soft type RJ series mounted (-XB22)	L	RJ0806H	RJ1007H	RJ1412H				

* The shock absorber service life is different from that of the MY1CW cylinder depending on operating conditions. Refer to the RB Series Specific Product Precautions for the replacement period.

* Mounted shock absorber soft type RJ series (-XB22) is made to order specifications. For details, refer to page 1468.

Shock Absorber Specifications

Model	RB 0806	RB 1007	RB 1412	RB 2015	
Max. energy absorption (J)	2.9	5.9	19.6	58.8	
Stroke absorption (mm)	6	7	12	15	
Max. collision speed (mm/s)	1500				
Max. operating frequency (cycle/min)	80	70	45	25	
Spring force (N)	Extended	1.96	4.22	6.86	8.34
	Retracted	4.22	6.86	15.98	20.50
Operating temperature range (°C)	5 to 60				

* The shock absorber service life is different from that of the MY1CW cylinder depending on operating conditions. Refer to the RB Series Specific Product Precautions for the replacement period.

MY1□W Series

Theoretical Output

Bore size (mm)	Piston area (mm ²)	Operating pressure (MPa)						(N)
		0.2	0.3	0.4	0.5	0.6	0.7	0.8
16	200	40	60	80	100	120	140	160
20	314	62	94	125	157	188	219	251
25	490	98	147	196	245	294	343	392
32	804	161	241	322	402	483	563	643
40	1256	251	377	502	628	754	879	1005
50	1962	392	588	784	981	1177	1373	1569
63	3115	623	934	1246	1557	1869	2180	2492

Weight

Bore size (mm)	MY1MW			MY1CW			Side support bracket weight (per set)	Stroke adjustment unit weight (per unit)		(kg)
	Basic weight	Additional weight per each 50 mm of stroke	Weight of moving parts	Basic weight	Additional weight per each 50 mm of stroke	Weight of moving parts	Type A and B	A unit weight	L unit weight	
16	1.25	0.16	0.54	1.25	0.16	0.57	0.01	0.03	0.04	
20	1.90	0.19	0.75	1.85	0.18	0.78	0.02	0.04	0.05	
25	2.56	0.28	1.00	2.50	0.28	1.02	0.02	0.07	0.11	
32	4.75	0.43	1.71	4.62	0.42	1.76	0.04	0.14	0.23	
40	7.79	0.61	2.56	7.51	0.57	2.64	0.08	0.25	0.34	
50	13.53	0.83	5.19	13.61	0.82	5.27	0.08	0.36	0.51	
63	21.84	1.18	8.23	21.94	1.17	8.50	0.17	0.68	0.83	

Calculation: (Example) **MY1MW25-300A**

- Basic weight..... 2.56 kg
- Cylinder stroke..... 300 stroke
- Additional weight..... 0.28/50 stroke
- $2.56 + 0.28 \times 300/50 + 0.07 \times 2 \approx 4.38$ kg
- Weight of A unit..... 0.07 kg

Option

Stroke Adjustment Unit Part No.

MYM-A 25 L2 - 6N

Stroke adjustment unit

Bore size

Bore size (mm)	Symbol	Stroke adjustment unit	Mounting position
16	A1	A unit	Left
20	A2	A unit	Right
25	L1	L unit	Left
32	L2	L unit	Right
40			
50			
63			

Unit no.

Unit no.	Intermediate fixing spacer
Nil	Without spacer
6	Short spacer
7	Long spacer

Spacer delivery type

Spacer delivery type	Unit installed
Nil	Unit installed
N	Spacer only

Note) Refer to page 1067 for details about adjustment range.

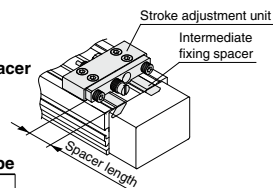

- Spacers are used to fix the stroke adjustment unit at an intermediate stroke position.
- Spacers are shipped for a set of two.

Component Parts

MYM-A25L2 (Without spacer)	MYM-A25L2-6 (With short spacer)	MYM-A25L2-7 (With long spacer)	MYM-A25L2-6N (Short spacer only)
			MYM-A25L2-7N (Long spacer only)

Side Support Part No.

Bore size (mm)	16	20	25	32	40	50	63
Side support A	MY-S16A	MY-S20A	MY-S25A	MY-S32A	MY-S40A		MY-S63A
Side support B	MY-S16B	MY-S20B	MY-S25B	MY-S32B	MY-S40B		MY-S63B

For details about dimensions, etc., refer to page 1074.

A set of side supports consists of a left support and a right support.

Mechanically Jointed Rodless Cylinder With Protective Cover **MY1□W Series**

Construction

MY1□W

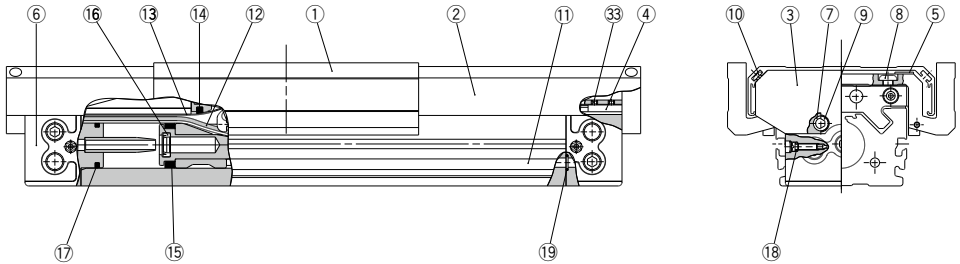

MY1□WK with side seal

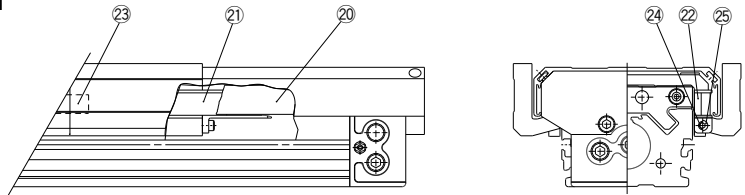

Component Parts

No.	Description	Material	Note	ø16	ø20	ø25	ø32	ø40	ø50	ø63
1	Slide table	Aluminum alloy	Hard anodized	MYMW-16-Stroke	MYMW-20-Stroke	MYMW-25-Stroke	MYMW-32-Stroke	MYMW-40-Stroke	MYMW-50-Stroke	MYMW-63-Stroke
2	Cover	Aluminum alloy	Hard anodized							
3	End plate	Aluminum alloy	Hard anodized							
4	Belt clamp	Special resin								
5	Slide plate	Special resin								
6	Port cover	Special resin (ø25 to ø40)								
7	Spacer	Stainless steel (ø25 to ø40)								
8	Hexagon socket button head screw	Chromium molybdenum steel	Chromated							
9	Hexagon socket head cap screw	Chromium molybdenum steel	Chromated							
10	Hexagon socket button head screw	Chromium molybdenum steel	Chromated							
11	Rodless cylinder	—	MY1M/MY1C	—	—	—	—	—	—	
21	Seal guide A	Special resin		MYMK-16-A	MYMK-16-A	MYMK-25-A	MYMK-25-A	MYMK-25-A	—	—
22	Seal guide B	Special resin								
23	Slide plate	Special resin								
24	Spacer	Stainless steel								
25	Hexagon socket head cap screw	Chromium molybdenum steel	Chromated							

Replacement Parts: Seal Kit

No.	Description	Qty.	ø16	ø20	ø25	ø32	ø40	ø50	ø63
12	Seal belt	1	MY16-16C-Stroke	MY20-16C-Stroke	MY25-16C-Stroke	MY32-16C-Stroke	MY40-16C-Stroke	MY50-16C-Stroke	MY63-16A-Stroke
13	Dust seal band ^(Note)	1	MY16-16B-Stroke	MY20-16B-Stroke	MY25-16B-Stroke	MY32-16B-Stroke	MY40-16B-Stroke	MY50-16B-Stroke	MY63-16B-Stroke
18	O-ring	2	KA00309 (ø4 x ø1.8 x ø1.1)	KA00311 (ø5.1 x ø3 x ø1.05)	KA00311 (ø5.1 x ø3 x ø1.05)	KA00320 (ø7.15 x ø3.75 x ø1.7)	KA00402 (ø8.3 x ø4.5 x ø1.9)	KA00777	KA00777
20	Side seal assembly	2	MYMK-16-Stroke	MYMK-20-Stroke	MYMK-25-Stroke	MYMK-32-Stroke	MYMK-40-Stroke	—	—
14	Scraper	2	—	—	—	—	—	—	—
15	Piston seal	2	—	—	—	—	—	—	—
16	Cushion seal	2	MY1M16-PS	MY1M20-PS	MY1M25-PS	MY1M32-PS	MY1M40-PS	MY1M50-PS	MY1M63-PS
17	Tube gasket	2	—	—	—	—	—	—	—
19	O-ring	4	—	—	—	—	—	—	—

Note) Two kinds of dust seal bands are available. Verify the type to use, since the part number varies depending on the treatment of the hexagon socket head set screw 33 (Refer to the Construction of MY1M on pages 980 and 981.).

A Black zinc chromated → MY□□-16B-Stroke B Chromated → MY□□-16BW-Stroke

* Seal kit includes 14, 15, 16, 17 and 19. Order the seal kit based on each bore size.

* Seal kit includes a grease pack (10 g).

When 12 and 13 are shipped as single units, a grease pack (10 g per 1000 strokes) is included.

Order with the following part number when only the grease pack is needed. **GR-S-010** (10 g), **GR-S-020** (20 g)

Mechanically Jointed Rodless Cylinder With Protective Cover **MY1□W Series**

Dimensions: $\varnothing 25$, $\varnothing 32$, $\varnothing 40$

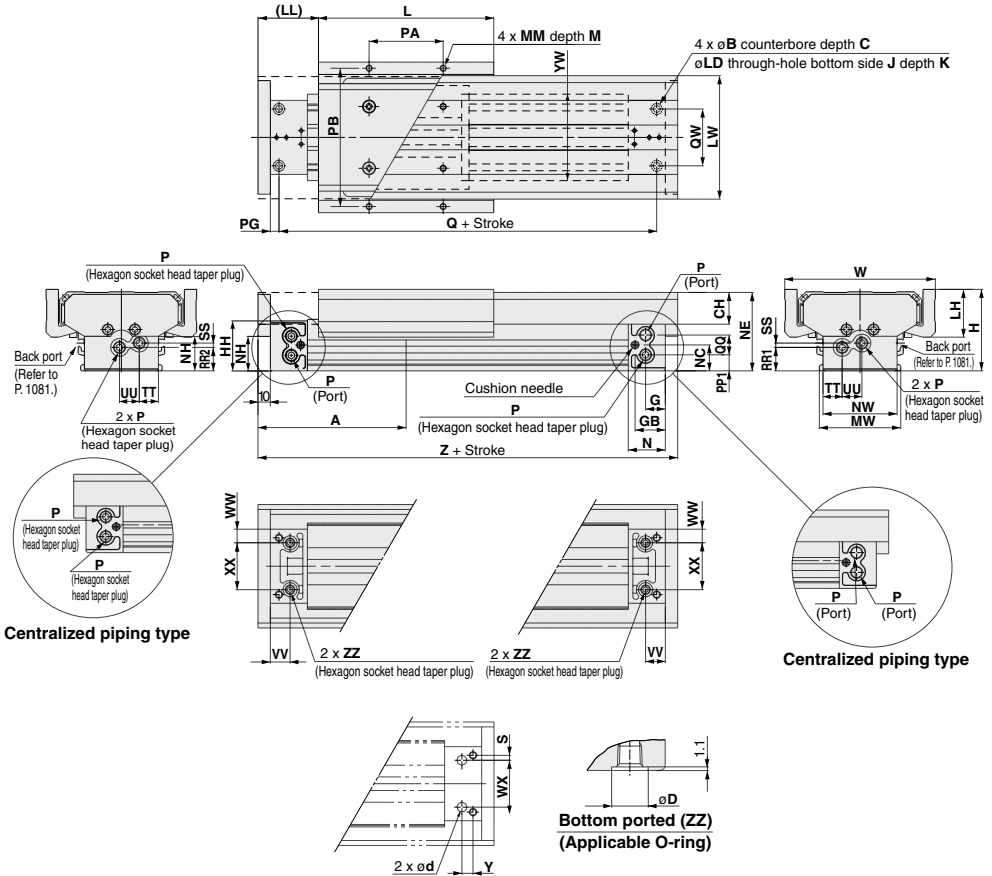

Bore size (mm)	A	B	C	CH	G	GB	H	HH	J	K	L	LD	LH	LL	LW	M	MM	MW	N	NC	NE	NH
25	120	9	5.5	25.7	17	24.5	66	40.5	M6 x 1	9.5	142	5.6	38.7	49	100	10	M5 x 0.8	66	30	21	64	28
32	150	11	6.5	31.5	19	30	82	50	M8 x 1.25	16	172	6.8	44.2	64	122	13	M6 x 1	80	37	26	80	37
40	180	14	8.5	34.8	23	36.5	98	63.5	M10 x 1.5	15	202	8.6	47.2	79	138	13	M6 x 1	96	45	32	96	48

Bore size (mm)	NW	P	PA	PB	PG	PP1	PP2	Q	QQ	QW	RR1	RR2	SS	TT	UU	VV	W	WW	YW	Z	ZZ	XX
25	60	Rc1/8	60	112	7	12.7	12.7	206	16	46	18.9	17.9	5.1	15.5	16	16	122	11	70	240	Rc1/16	38
32	74	Rc1/8	80	134	8	15.5	18.5	264	16	60	22	24	4	21	16	19	144	13	88	300	Rc1/16	48
40	94	Rc1/4	100	150	9	17.5	20	322	26	72	25.5	29	9	26	21	23	160	20	104	360	Rc1/8	54

Hole Size for Centralized Piping on the Bottom (Mounting side should be machined to these dimensions.)

Bore size (mm)	D	d	WX	Y	S	Applicable O-ring
25	11.4	6	38	9	4	C9
32	11.4	6	48	11	6	C9
40	13.4	8	54	14	9	C11.2

MY1□W Series

Dimensions: $\phi 50$, $\phi 63$

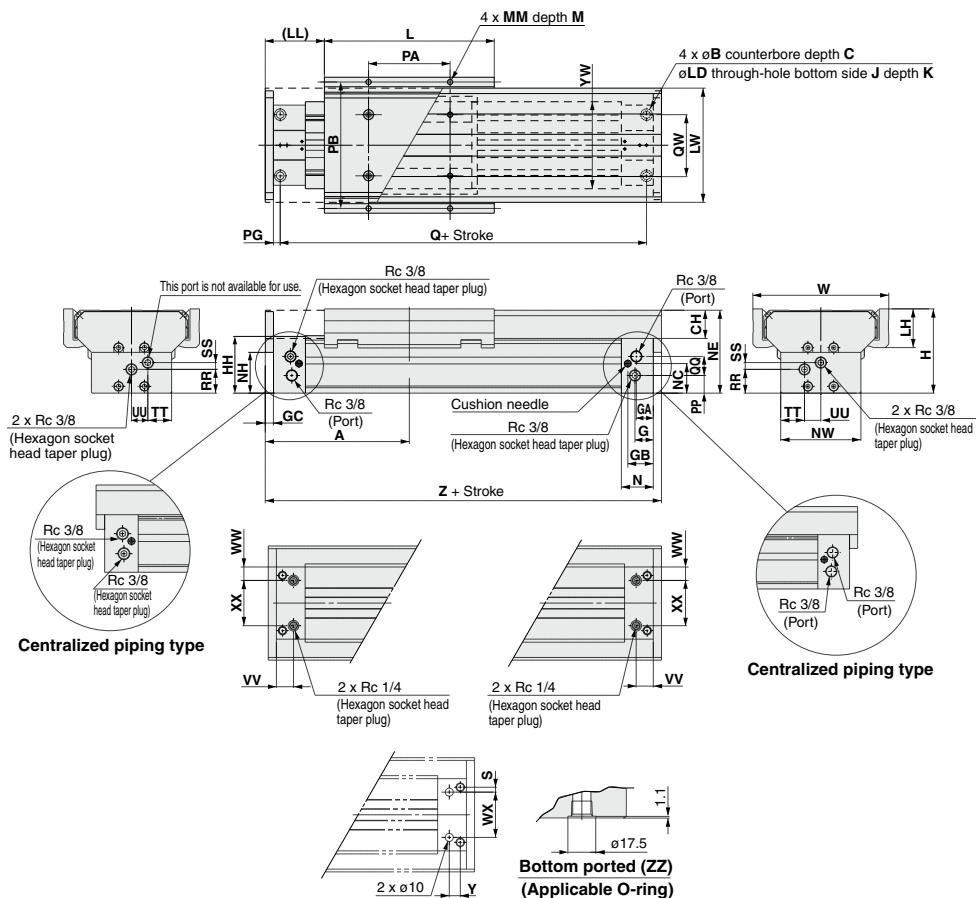

Bore size (mm)	A	B	C	CH	G	GA	GB	GC	H	HH	J	K	L	LD	LH	LL	LW	M	MM	N	NC	NE
50	212	17	10.5	41.5	27	25	37.5	12	124	83.5	M14 x 2	28	250	11	57	87	168	15	M8 x 1.25	47	44	122
63	245	19	12.5	47	29.5	27.5	39.5	15	149	105	M16 x 2	32	290	14	65	100	200	16	M10 x 1.5	50	60	147
Bore size (mm)	NH	NW	PA	PB	PG	PP	Q	QQ	QW	RR	SS	TT	UU	VV	W	WW	YW	Z	XX			
50	60	118	120	186	10	26	380	28	90	35	10	35	24	28	200	22	128	424	74			
63	70	142	140	220	12	42	436	30	110	49	13	43	28	30	236	25	152	490	92			

Hole Size for Centralized Piping on the Bottom

(Mounting side should be machined to these dimensions.)

Bore size (mm)	S	WX	Y	Applicable O-ring
50	8	74	18	C15
63	9	92	18	C15

Stroke Adjusting Unit

With adjusting bolt

MY1□W **□** Bore size – **□** Stroke **A**

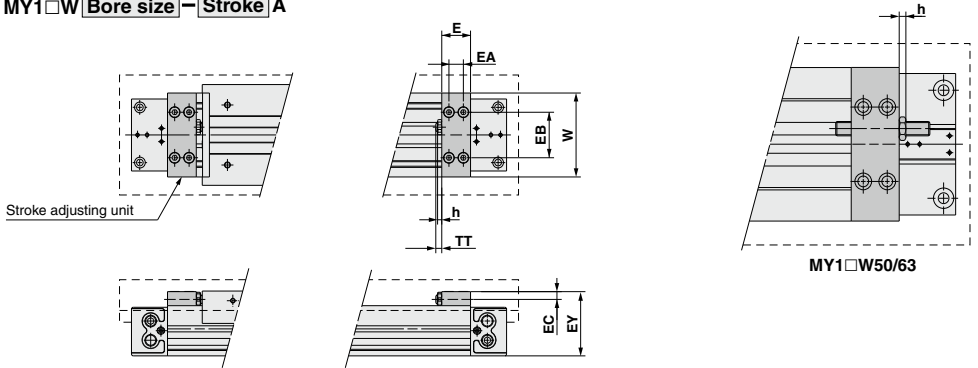

Model	E	EA	EB	EC	EY	h	TT	W
MY1□W16	14.6	7	30	5.8	39.5	3.6	5.4 (Max.11)	58
MY1□W20	20	10	32	5.8	45.5	3.6	5 (Max.11)	58
MY1□W25	24	12	38	6.5	53.5	3.5	5 (Max.16.5)	70
MY1□W32	29	14	50	8.5	67	4.5	8 (Max.20)	88
MY1□W40	35	17	57	10	83	4.5	9 (Max.25)	104
MY1□W50	40	20	66	14	106	5.5	13 (Max.33)	128
MY1□W63	52	26	77	14	129	5.5	13 (Max.38)	152

With low load shock absorber + Adjusting bolt

MY1□W **□** Bore size – **□** Stroke **L**

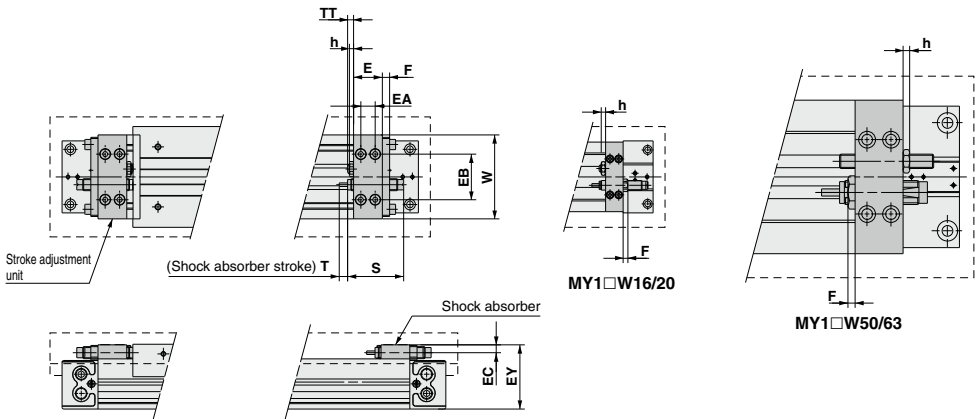

Model	E	EA	EB	EC	EY	F	h	S	T	TT	W	Shock absorber model
MY1□W16	14.6	7	30	5.8	39.5	4	3.6	40.8	6	5.4 (Max.11)	58	RB0806
MY1□W20	20	10	32	5.8	45.5	4	3.6	40.8	6	5 (Max.11)	58	RB0806
MY1□W25	24	12	38	6.5	53.5	6	3.5	46.7	7	5 (Max.16.5)	70	RB1007
MY1□W32	29	14	50	8.5	67	6	4.5	67.3	12	8 (Max.20)	88	RB1412
MY1□W40	35	17	57	10	83	6	4.5	67.3	12	9 (Max.25)	104	RB1412
MY1□W50	40	20	66	14	106	6	5.5	73.2	15	13 (Max.33)	128	RB2015
MY1□W63	52	26	77	14	129	6	5.5	73.2	15	13 (Max.38)	152	RB2015

(mm)

MY1□W Series

Side Support

Side support A
MY-S□A

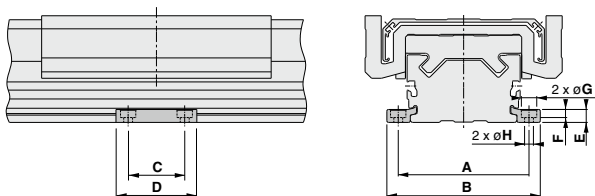

Side support B
MY-S□B

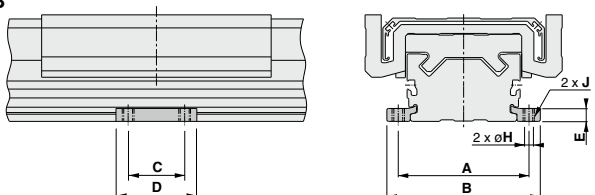

Model	Applicable cylinder	A	B	C	D	E	F	G	H	J
MY-S16 ^A _B	MY1□W16	61	71.6	15	26	4.9	3	6.5	3.4	M4 x 0.7
MY-S20 ^A _B	MY1□W20	67	79.6	25	38	6.4	4	8	4.5	M5 x 0.8
MY-S25 ^A _B	MY1□W25	81	95	35	50	8	5	9.5	5.5	M6 x 1
MY-S32 ^A _B	MY1□W32	100	118	45	64	11.7	6	11	6.6	M8 x 1.25
MY-S40 ^A _B	MY1□W40	120	142	55	80	14.8	8.5	14	9	M10 x 1.5
MY-S63 ^A _B	MY1□W63	172	202	70	100	18.3	10.5	17.5	11.5	M12 x 1.75

* A set of side supports consists of a left support and a right support.

Guide for Side Support Application

For long stroke operation, the cylinder tube may be deflected depending on its own weight and the load. In such a case, use a side support in the middle section. The spacing (L) of the support must be no more than the values shown in the graph on the right.

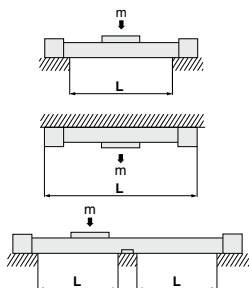

Caution

- If the cylinder mounting surfaces are not measured accurately, using a side support may cause poor operation. Therefore, be sure to level the cylinder tube when mounting. Also, for long stroke operation involving vibration and impact, use of a side support is recommended even if the spacing value is within the allowable limits shown in the graph.
- Support brackets are not for mounting; use them solely for providing support.

MY1MW

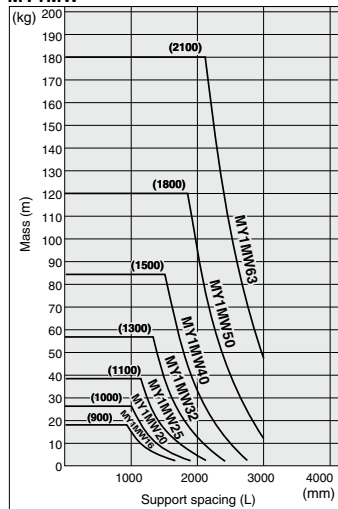

MY1CW

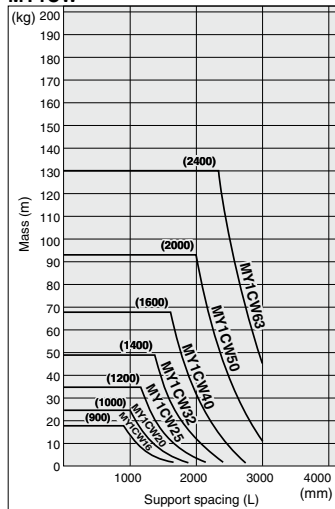

MY1□W Series

Auto Switch Mounting 1

Proper Auto Switch Mounting Position (Detection at stroke end)

MY1MW (Slide bearing guide type)

ø16, ø20

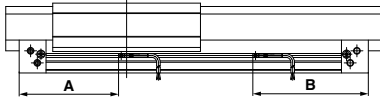

ø25, ø32, ø40, ø50, ø63

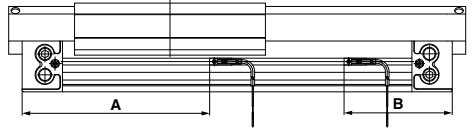

Proper Auto Switch Mounting Position

Bore size (mm)	D-M9□ D-M9□W D-M9□A		D-M9□V D-M9□WV D-M9□AV		D-A9□		D-Y69□/Y7PV D-Y7□WV		D-Z7□/Z80 D-Y59□/Y7P D-Y7□W D-Y7BA	
	A	B	A	B	A	B	A	B	A	B
16	74	86	—	—	70	90	—	—	—	—
20	94	106	—	—	90	110	—	—	—	—
25	144.5	75.5	144.5	75.5	—	—	139.5	80.5	139.5	80.5
32	189.5	90.5	189.5	90.5	—	—	184.5	95.5	184.5	95.5
40	234.5	105.5	234.5	105.5	—	—	229.5	110.5	229.5	110.5
50	283.5	116.5	—	—	—	—	—	—	278.5	121.5
63	328.5	131.5	—	—	—	—	—	—	323.5	136.5

Note 1) Perpendicular electrical entry type and D-Y7BA cannot be mounted on ø16, 20, 50 and 63. Consider using the in-line electrical entry type.
 Note 2) Adjust the auto switch after confirming the operating conditions in the actual setting.

MY1CW (Cam follower guide type)

ø16, ø20

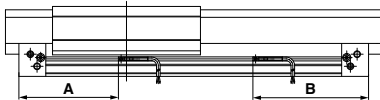

ø25, ø32, ø40, ø50, ø63

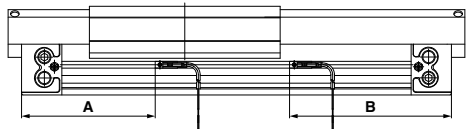

Proper Auto Switch Mounting Position

Bore size (mm)	D-M9□ D-M9□W D-M9□A		D-M9□V D-M9□WV D-M9□AV		D-A9□		D-Y69□/Y7PV D-Y7□WV		D-Z7□/Z80 D-Y59□/Y7P D-Y7□W D-Y7BA	
	A	B	A	B	A	B	A	B	A	B
16	74	86	—	—	70	90	—	—	—	—
20	94	106	—	—	90	110	—	—	—	—
25	102	118	102	118	—	—	97	123	97	123
32	132	148	132	148	—	—	127	153	127	153
40	162.5	177.5	162.5	177.5	—	—	157.5	182.5	157.5	182.5
50	283.5	116.5	—	—	—	—	—	—	278.5	121.5
63	328.5	131.5	—	—	—	—	—	—	323.5	136.5

Note 1) Perpendicular electrical entry type and D-Y7BA cannot be mounted on ø16, 20, 50 and 63. Consider using the in-line electrical entry type.
 Note 2) Adjust the auto switch after confirming the operating conditions in the actual setting.

MY1□W Series

Auto Switch Mounting 2

(Note) Since the operating range is provided as a guideline including hysteresis, it cannot be guaranteed. (Assuming approximately ±30% dispersion.) It may vary substantially depending on an ambient environment.

Operating range

MY1MW (Slide bearing guide type) (mm)

Auto switch model	Bore size						
	16	20	25	32	40	50	63
D-A9□	11	7.5	—	—	—	—	—
D-M9□/M9□V D-M9□W/M9□WV D-M9□A/M9□AV	7.5	7.5	8.5	8.5	9.5	7	6
D-Z7□/Z80	—	—	12	12	12	11.5	11.5
D-Y59□/Y69□ D-Y7P/Y7PV D-Y7□W/Y7□WV D-Y7BA	—	—	5	5	5	5.5	5.5

Perpendicular electrical entry type and D-Y7BAL cannot be mounted on ø16, 20, 50 and 63. Consider using the in-line electrical entry type.

MY1CW (Cam follower guide type) (mm)

Auto switch model	Bore size						
	16	20	25	32	40	50	63
D-A9□	11	7.5	—	—	—	—	—
D-M9□/M9□V D-M9□W/M9□WV D-M9□A/M9□AV	7.5	7.5	7	8	8.5	7	6
D-Z7□/Z80	—	—	12	12	12	11.5	11.5
D-Y59□/Y69□ D-Y7P/Y7PV D-Y7□W/Y7□WV D-Y7BA	—	—	5	5	5	5.5	5.5

Perpendicular electrical entry type and D-Y7BAL cannot be mounted on ø16, 20, 50 and 63. Consider using the in-line electrical entry type.

Switch Mounting Bracket: Part No.

Auto switch model	Bore size (mm)	
	ø16, ø20	ø25 to ø63
D-M9□/M9□V D-M9□W/M9□WV D-M9□A/M9□AV	—	BMG2-012

ø25 to ø63: M9□(V)/M9□W(V)/M9□A(V)

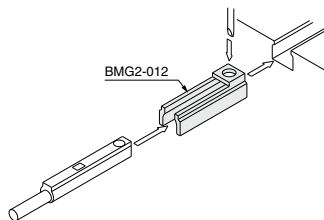

Besides the models listed in How to Order, the following auto switches are applicable.
For detailed specifications, refer to pages 1289 to 1383.

Type	Model	Electrical entry (Fetching direction)	Features	Applicable bore size
Solid state auto switch	D-Y69A, Y69B, Y7PV	Grommet (Perpendicular)	—	ø25 to ø40
	D-Y7NWV, Y7PWV, Y7BWV		Diagnostic indication (2-color indicator)	
	D-Y59A, Y59B, Y7P	Grommet (In-line)	—	ø25 to ø63
	D-Y7NW, Y7PW, Y7BW		Diagnostic indication (2-color indicator)	

* For solid state auto switches, auto switches with a pre-wired connector are also available. Refer to pages 1358 and 1359 for details.

* Normally closed (NC = b contact) solid state auto switches (D-M9□E(V)/Y7G/Y7H) are also available. Refer to pages 1308 and 1310 for details.

Mounting of Auto Switch & Installation of Lead Wire Cover (ø50, ø63)**! Caution**

Be sure to install a lead wire cover on the auto switches for size ø50 and ø63 cylinders.

Install a lead wire cover following the procedures provided below to prevent the lead wire from interfering with the slider.

Lead wire cover is packaged together with size ø50 and ø63 cylinders equipped with auto switches.

For ordering the lead wire cover separately, use the following part number:

MYM63GAR6386-1640 (Length: 2 m)

1. Auto switch mounting position

Up to 4 auto switches can be mounted on one side of the cylinder (total of 8 switches on both sides).

When multiple auto switches are used, be sure to use the lead wire groove and pull the lead wires out from the edge of the cylinder. (Bold lines in Fig. (1) indicate lead wires.)

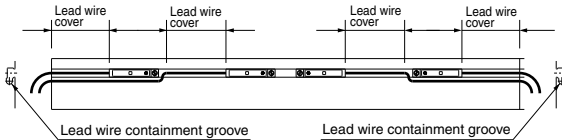

Fig. (1) Auto switch mounting position

2. How to mount auto switch/install lead wire cover

- 1) Insert and slide in the auto switch from the side of the cylinder and secure it with the screw provided. (Refer to Fig. (2).)
- 2) Cut the lead wire cover to the desired length using a cutter or tube cutter. (Refer to Fig. (1).)
- 3) First place the lead wires into the lead wire cover. Then, install a lead wire cover onto a cylinder body. (Refer to Fig. (3).)
- 4) Make sure that the lead wires do not interfere with the slide table at any stroke range.

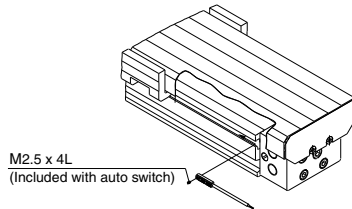

Fig. (2) Auto switch mounting

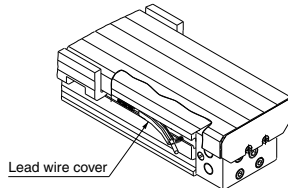

Fig. (3) Installation of lead wire cover



MY1□W Series

Specific Product Precautions 1

Be sure to read this before handling the products.

Refer to page 8 for safety instructions and pages 9 to 18 for actuator and auto switch precautions.

Selection

⚠ Caution

1. When using a cylinder with long strokes, implement an intermediate support.

- When using a cylinder with long strokes, implement an intermediate support to prevent the tube from sagging and being deflected by vibration or an external load. Refer to the Guide for Side Support Application on page 1074.

2. For intermediate stops, use a dual-side pressure control circuit.

- Since the mechanically jointed rodless cylinders have a unique seal structure, slight external leakage may occur. Controlling intermediate stops with a 3 position valve cannot hold the stopping position of the slide table (slider). The speed at the restarting state also may not be controllable. Use the dual-side pressure control circuit with a PAB-connected 3 position valve for intermediate stops.

3. Constant speed

- Since the mechanically jointed rodless cylinders have a unique seal structure, a slight speed change may occur. For applications that require constant speed, select an applicable equipment for the level of demand.

4. Load factor of 0.5 or less

- When the load factor is high against the cylinder output, it may adversely affect the cylinder (condensation, etc.) and cause malfunctions. Select a cylinder to make the load factor less than 0.5. (Mainly when using an external guide)

5. Cautions on less frequent operation

- When the cylinder is used extremely infrequently, operation may be interrupted in order for anchoring and a change lubrication to be performed or service life may be reduced.

6. Consider uncalculated loads such as piping, cableveyor, etc., when selecting a load moment

- Calculation does not include the external acting force of piping, cableveyor, etc. Select load factors taking into account the external acting force of piping, cableveyor, etc.

7. Accuracy

- The mechanical jointed rodless cylinder does not guarantee traveling parallelism. When accuracy in traveling parallelism and a middle position of stroke is required, please consult with SMC.

Mounting

⚠ Caution

1. To obtain the best results from the cover, horizontal mounting is recommended.

- With horizontal mounting (shown below), the entry of dirt and dust from the bottom of the cover is much less compared to other mounting orientations, making it much more efficient.

Horizontal mounting



Mounting

⚠ Caution

2. When the cylinder is mounted from the top side or when strokes are to be adjusted by installing a stroke adjusting unit, the protective cover must be removed for these purposes.

- For detailed assembly step, refer to page 1080.

3. Do not apply a strong impact or moment on the slide table (slider).

- Since the slide table (slider) is supported by precision bearings, do not subject it to strong impact or excessive moment when mounting workpieces.

4. When connecting to a load which has an external guide mechanism, use a discrepancy absorption mechanism.

- A mechanically jointed rodless cylinder can be used with a direct load within the allowable range for each guide type, however, align carefully when connecting to a load with an external guide mechanism.

5. Do not mount cylinders as they are twisted.

- When mounting, be sure for a cylinder tube not to be twisted. The flatness of the mounting surface is not appropriate, the cylinder tube is twisted, which may cause air leakage due to the detachment of a seal belt, damage a dust seal band, and cause malfunctions.

6. Do not mount a slide table on the fixed equipment surface.

- It may cause damage or malfunctions since an excessive load is applied to the bearing.

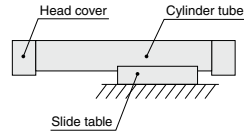

Mounting with a slide table (slider)

7. Consult SMC when mounting in a cantilevered way.

- Since the cylinder body deflects, it may cause malfunctions. Please consult with SMC when using it this way.

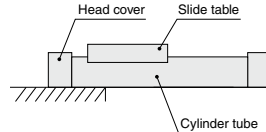

Mounting in a cantilevered way



MY1□W Series

Specific Product Precautions 2

Be sure to read this before handling the products.

Refer to page 8 for safety instructions and pages 9 to 18 for actuator and auto switch precautions.

Mounting

⚠ Caution

8. Fixed parts of the cylinder on both ends must have at least 5 mm of contact between where the bottom of the cylinder tube and the equipment surface.

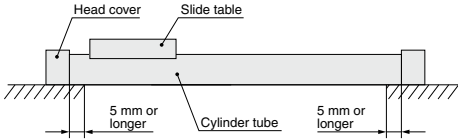

9. Do not generate negative pressure in the cylinder tube.

- Take precautions under operating conditions in which negative pressure is generated inside the cylinder by external forces or inertial forces. Air leakage may occur due to separation of the seal belt. Do not generate negative pressure in the cylinder by forcibly moving it with an external force during the trial operation or dropping it with self-weight under the non-pressure state, etc. When the negative pressure is generated, slowly move the cylinder by hand and move the stroke back and forth. (When using with a stroke adjustment unit, please either remove the unit or adjust the stroke to the full stroke.) After doing so, if air leakage still occurs, please consult with SMC.

10. Accuracy

- The mechanical jointed rodless cylinder does not guarantee traveling parallelism. When accuracy in traveling parallelism and a middle position of stroke is required, consult with SMC.

11. Cautions on less frequent operation

- When the cylinder is used extremely infrequently, operation may be interrupted in order for anchoring and a change lubrication to be performed or service life may be reduced.

12. Do not unnecessarily alter the guide adjustment setting.

- The adjustment of the guide is preset and does not require readjustment under normal operating conditions. Therefore, do not unnecessarily alter the guide adjustment setting. However, series other than the MY1□W series can be readjusted and their bearings can be replaced. To perform these operations, refer to the bearing replacement procedure given in the operation manual.

13. Do not get your hands caught during cylinder operation.

- For the cylinder with a stroke adjusting unit, the space between the slide table and stroke adjusting unit is very small, and your hands may get caught. When operating without a protective cover, be careful not to get your hands caught.

Operating Environment

⚠ Caution

1. Because of floating particles such as paper dust and coolant mist that may enter the inside of the cover.

- Since there is a gap between the bottom of the cover and cylinder tube, take precautions when operating cylinders in environments where there is exposure to excessive amount of floating particles, water/oil splash, or chip spattering. If they enter inside the cover, malfunction may occur.

2. Carry out cleaning and grease application suitable for the operating environment.

- Carry out cleaning regularly when using in an operating environment in which the product is likely to get dirty. After cleaning, be sure to apply grease to the top side of the cylinder tube and the rotating part of the dust seal band. Apply grease to these parts regularly even if not after cleaning. Please consult with SMC for the cleaning of the slide table (slider) interior and grease application.

Service Life and Replacement Period of Shock Absorber

⚠ Caution

1. Allowable operating cycle under the specifications set in this catalog is shown below.

1.2 million times RB08□□

2 million times RB10□□ to RB2725

(Note) Specified service life (suitable replacement period) is the value at room temperature (20 to 25°C). The period may vary depending on the temperature and other conditions. In some cases the absorber may need to be replaced before the allowable operating cycle above.



MY1□W Series

Specific Product Precautions 3

Be sure to read this before handling the products.

Refer to page 8 for safety instructions and pages 9 to 18 for actuator and auto switch precautions.

Assembly Procedure

1 Component check

Check the components.

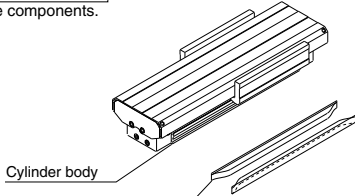

Cylinder body

Side seal assembly

(Applies to models that come with side seal only)

Note) When auto switches are included with a cylinder order, they are packaged together with the cylinder.

2 Body mounting procedures

1. Removal of cover

Remove the hexagon socket head button bolts and cover.

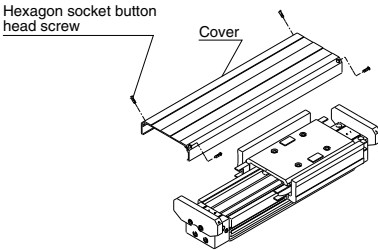

Hexagon socket button head screw

Cover

2. Body mounting/adjustment

Mount the cylinder body.

For cylinders with protective cover only (i.e., without side seal), reinstall the cover after the cylinder is mounted and adjusted. (Refer to Step 3-3 "Cover installation".)

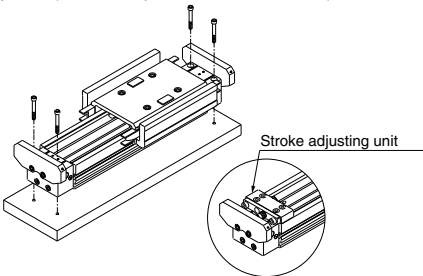

Stroke adjusting unit

Note) The adjustment of the stroke adjusting unit (optional) should also be done at this time.

3 Side seal installation procedures

1. Temporary cover installation

- 1) Remove the hexagon socket head cap screws and one of the end plates.
- 2) Place the cover and temporarily secure it with the hexagon socket button head bolts.

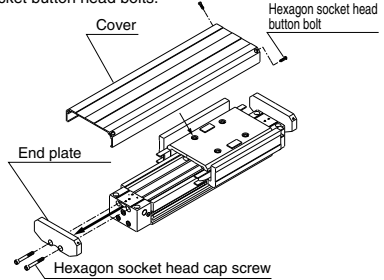

Cover

Hexagon socket head button bolt

End plate

Hexagon socket head cap screw

2. Side seal installation

Slide the side seal assembly into the place from one end of the cylinder.

⚠ Stainless steel portions of the side seal assembly are very sharp. Take extra precautions when handling.

⚠ Caution

If the fixing brackets on both ends of the side seal assembly aren't thick enough, the side seal assembly may fall from the product while it is in use. As the product is adjusted to the most suitable thickness at the time of shipment, please use it as is.

Note) Move the slide table to the end of the insertion side.

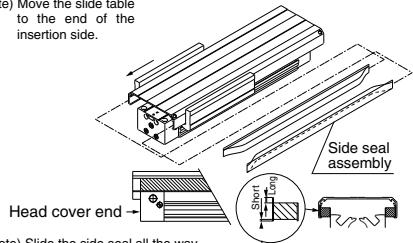

Side seal assembly

Head cover end

Note) Slide the side seal all the way to the end of the head cover.

Note) Make sure the side seal assembly is facing in the right direction.



MY1□W Series

Specific Product Precautions 4

Be sure to read this before handling the products.

Refer to page 8 for safety instructions and pages 9 to 18 for actuator and auto switch precautions.

Assembly Procedure

4 Side seal installation procedures (Continued)

3. Cover installation

* Be sure to confirm Note 1) and Note 2). (When adjustment is not correctly done, it may cause malfunctions and parts damage (cover collision).)

- 1) The end plate is fixed with hexagon socket head cap screws.
- 2) The cover is fixed with hexagon socket button head screws.

Hexagon socket button head screw

Cover tightening torque [N·m]

Bore	Thread size	Torque
ø16 to ø40	M3	0.6
ø50, ø63	M4	1.4

End plate

Note 1) Do not move the end plate upward inadvertently.

Hexagon socket head cap screw

End plate tightening torque [N·m]

Bore	Thread size	Torque
ø16	M3	0.7
ø20	M4	1.8
ø25	M5	3.5
ø32	M6	5.8
ø40	M6	5.8
ø50	M8	14
ø63	M10	28

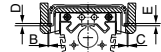

Note 2) If there is no gap (clearance) between the slide table and cover (B, C and D, E in the drawing above) throughout the stroke range, loosen the hexagon socket head cap screw to fix the end plate, then retighten it after adjusting the end plate position.

Centralized Piping Port Variations

⚠ Caution

• Head cover piping connection can be freely selected to best suit different piping conditions.

Applicable cylinder	Port variation
MY1MW16, 20, 50, 63 MY1CW16, 20, 50, 63	<p>This port cannot be used. (Except ø50)</p> <p>Slide table operating direction</p>
MY1MW25, 32, 40 MY1CW25, 32, 40	<p>Slide table operating direction</p>

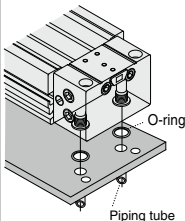

For bottom piping, refer to the figure above.