

Longer Life Cylinder

New technology offers at least
4 times better durability

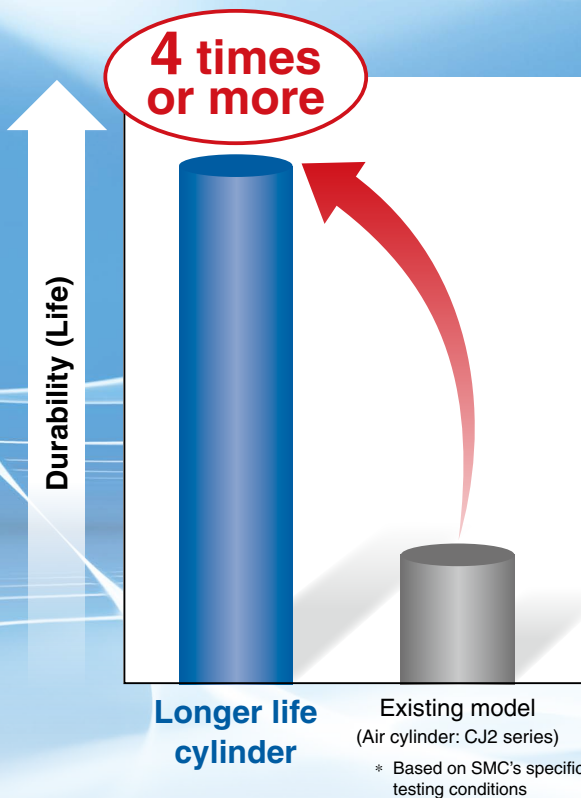

- The maintenance intervals will be extended



- Employs the same specification and dimensions as the existing models, CJ2 Air Cylinder series

High Durability Series

High Durability Series is the series name for the "special specification" that offers superior durability and environmental resistance compared to standard products.

Series Variations

Series	Action	Model	Bore size [mm]			Cushion	Manufacturable stroke [mm]
			6	10	16		
Air cylinder CJ2 series 	Double acting, Single rod	CJ2-XB24	●	●	●	Rubber bumper	ø6 : 15 to 200 ø10: 15 to 400 ø16: 15 to 400

CJ2-XB24

High Durability Series

Longer Life Cylinder Double Acting, Single Rod

CJ2-XB24

ø6, ø10, ø16



How to Order

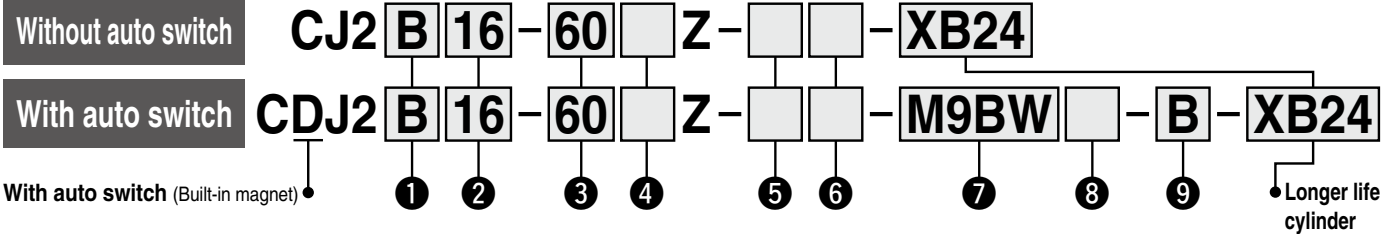

1 Mounting

B	Basic
E	Double-side bossed
D	Double clevis
L	Single foot bracket
M	Double foot bracket
F	Rod flange
G	Head flange

- * Foot brackets or flanges are shipped together with the product, but not assembled.
- * A double clevis is only available for ø10 and ø16.

6 Rod end bracket

Nil	None
V	Single knuckle joint
W	Double knuckle joint
T	Rod end cap (Flat type)
U	Rod end cap (Round type)

- * A rod end bracket is shipped together with the product, but not assembled.
- * Single/Double knuckle joint: ø10 and ø16 only

2 Bore size

6	6 mm
10	10 mm
16	16 mm

3 Cylinder manufacturable stroke [mm]

Refer to the "Manufacturable Strokes" on page 2.

4 Head cover port location

Nil	Perpendicular to axis	
R	Axial	

- * For the double clevis, the product is perpendicular to the cylinder axis.
- * For the double-side bossed, the product is perpendicular to the cylinder axis.

5 Pivot bracket

Nil	None
N	Pivot bracket is shipped together with the product.

- * Only for the double clevis type (ø10 and ø16)
- * A pivot bracket is shipped together with the product, but not assembled.

7 Auto switch

Nil	Without auto switch
-----	---------------------

- * For applicable auto switches, refer to the table below.

★ Enter the auto switch mounting type (A or B) even when a built-in magnet cylinder without an auto switch is required.

8 Number of auto switches

Nil	2
S	1
n	n

9 Auto switch mounting type

A	Rail mounting
B	Band mounting

- * For the rail mounting, screws and nuts for 2 auto switches come with the rail.
- * Refer to the **Web Catalog** for auto switch mounting brackets.
- * ø6: Band mounting only

* Refer to the "Ordering Example of Cylinder Assembly" on page 2.

Applicable Auto Switches / Refer to the Web Catalog for further information on auto switches.

Type	Special function	Electrical entry	Indicator light	Wiring (Output)	Load voltage		Auto switch model				Lead wire length [m]					Pre-wired connector	Applicable load				
					DC	AC	Band mounting		Rail mounting		0.5 (Nil)	1 (M)	3 (L)	5 (Z)	None (N)						
							Perpendicular	In-line	Perpendicular	In-line											
Solid state auto switch	—	Grommet	No	3-wire (NPN)	5 V, 12 V	—	M9NV	M9N	M9NV	M9N	●	●	●	○	—	○	IC circuit				
				3-wire (PNP)			M9PV	M9P	M9PV	M9P	●	●	●	○	—	○					
		Connector	Yes	2-wire			M9BV	M9B	M9BV	M9B	●	●	●	○	—	○					
				—			H7C	J79C	—	●	—	●	●	●	—	—					
	Diagnostic indication (2-color indicator)	Grommet	Yes	3-wire (NPN)	24 V	5 V, 12 V	—	M9NWV	M9NW	M9NWV	M9NW	●	●	●	○	—	○	IC circuit			
				3-wire (PNP)				M9PWV	M9PW	M9PWV	M9PW	●	●	●	○	—	○				
		Connector	No	2-wire				M9BWV	M9BW	M9BWV	M9BW	●	●	●	○	—	○				
				—				H7C	J79C	—	●	—	●	●	●	—	—				
		Grommet	Yes	3-wire (NPN)				M9NAV*1	M9NA*1	M9NAV*1	M9NA*1	○	○	●	○	—	○		IC circuit		
				3-wire (PNP)				M9PAV*1	M9PA*1	M9PAV*1	M9PA*1	○	○	●	○	—	○				
Connector	No	2-wire	M9BAV*1	M9BA*1	M9BAV*1	M9BA*1	○	○	●	○	—	○	IC circuit								
		4-wire (NPN)	—	H7NF	—	F79F	●	—	●	○	—	○									
Reed auto switch	—	Grommet	Yes	3-wire (NPN equivalent)	5 V	—	A96V	A96	A96V	A96	●	—	●	—	—	—	IC circuit				
				Connector			No	2-wire	24 V	12 V	—	—	A72	A72H	●	—		●	—	—	—
											100 V	A93V*2	A93	A93V*2	A93	●		●	●	●	
		Grommet	Yes	2-wire	24 V	12 V	100 V or less	A90V	A90	A90V	A90	●	—	●	—	—	IC circuit				
							—	—	C73C	A73C	—	●	—	●	●	●		—	—		
		Connector	No	2-wire	24 V	12 V	24 V or less	—	—	C80C	A80C	—	●	—	●	●	IC circuit				
							—	—	—	A79W	—	—	●	—	●	—		—			

- *1 Water-resistant type auto switches can be mounted on the models, but SMC cannot guarantee water resistance. Please contact SMC regarding water-resistant types with the above model numbers.
- *2 The 1 m lead wire is only applicable to the D-A93.

* Lead wire length symbols: 0.5 m..... Nil (Example) M9NW 5 m..... Z (Example) M9NWZ
 1 m..... M (Example) M9NWM None..... N (Example) H7CN
 3 m..... L (Example) M9NWL

* Since there are applicable auto switches other than those listed above, refer to the **Web Catalog** for details.

* Solid state auto switches marked with a "○" are produced upon receipt of order

* The D-A9□/M9□/A7□/A80□/F7□/J7□ auto switches are shipped together, but not assembled. (For the band mounting, only the auto switch mounting brackets are assembled before shipment.)

Specifications



Bore size [mm]	6	10	16
Action	Double acting, Single rod		
Fluid	Air		
Proof pressure	1 MPa		
Max. operating pressure	0.7 MPa		
Min. operating pressure	0.12 MPa	0.06 MPa	
Ambient and fluid temperatures	Without auto switch: -10°C to 70°C With auto switch: -10°C to 60°C (No freezing)		
Cushion	Rubber bumper		
Lubrication	Not required (Non-lube)		
Piston speed	50 to 750 mm/s		
Allowable kinetic energy	0.012 J	0.035 J	0.090 J
Stroke length tolerance		$\begin{matrix} +1.0 \\ 0 \end{matrix}$	

Symbol

Rubber bumper

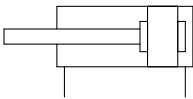

Manufacturable Strokes

Bore size	Manufacturable stroke [mm]
6	15 to 200
10	15 to 400
16	15 to 400

* The manufacturing of strokes in 1 mm increments is possible. (Spacers are not used.)
 Produced upon receipt of order.

* Applicable strokes should be confirmed according to the usage. For details, refer to the "Air Cylinders Model Selection" in the **Web Catalog**. Note that if the stroke is long, the specifications may not be satisfied due to deflection or other causes.

Mounting and Accessories

●...Mounted on the product. ○...Can be ordered within the cylinder model. △...Order it separately.

Mounting		Basic	Foot bracket	Flange	Double*1 clevis	Double clevis (including T-bracket)
Standard	Mounting nut	●	●	●	—	—
	Rod end nut	●	●	●	●	●
	Clevis pin (including retaining rings)	—	—	—	●	●
Option	Double clevis (With one-touch connecting pin)	△	△	△	—	—
	Single knuckle joint	○	○	○	○	○
	Double knuckle joint (including a pin and retaining rings)	○	○	○	○	○
	Double knuckle joint (With one-touch connecting pin)	△	△	△	△	△
	Rod end cap (Flat/Round type)	○	○	○	○	○
	Pivot bracket (T-bracket)	—	—	—	○	●

*1 A double clevis is only available for $\phi 10$ and $\phi 16$.

* Stainless steel mounting brackets and accessories are also available. Refer to the **Web Catalog** for details.

Ordering Example of Cylinder Assembly

Cylinder model:

CDJ2D16-60Z-NW-M9BW-B-XB24

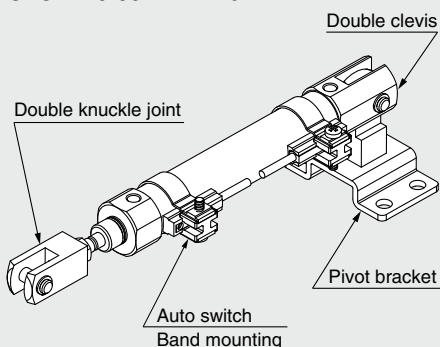

Mounting D: Double clevis
Pivot bracket N: Yes
Rod end bracket W: Double knuckle joint
Auto switch D-M9BW: 2 pcs.
Auto switch mounting B: Band mounting

* Pivot brackets, double knuckle joints, and auto switches are shipped together with the product, but not assembled.

* Except $\phi 6$

Mounting Bracket Part Nos.

Mounting bracket	Bore size [mm]		
	6	10	16
Foot bracket	CJ-L006C	CJ-L010C	CJ-L016C
Flange	CJ-F006C	CJ-F010C	CJ-F016C
T-bracket*1	—	CJ-T010C	CJ-T016C

*1 A T-bracket is used with double clevis (D).

The mounting pitch and shape of this product with auto switch are the same as those of the Air Cylinder CJ2 series with auto switch. For details, refer to the **Web Catalog**.

- Auto Switch Proper Mounting Position (Detection at stroke end) and Mounting Height
- Min. Stroke for Auto Switch Mounting
- Operating Range
- Auto Switch Mounting Brackets/Part Nos.

Moisture Control Tube IDK Series



When operating an actuator with a small bore size and a short stroke at a high frequency, dew condensation (water droplets) may occur inside the piping depending on the conditions. Simply connecting the moisture control tube to the actuator will prevent dew condensation from occurring. For details, refer to the **Web Catalog**.

The operating speed, allowable loads at the rod end, theoretical output, weight, and accessory are equivalent to those of the Air Cylinder CJ2 series. For details, refer to the Web Catalog.

Dimensions

Basic (B)

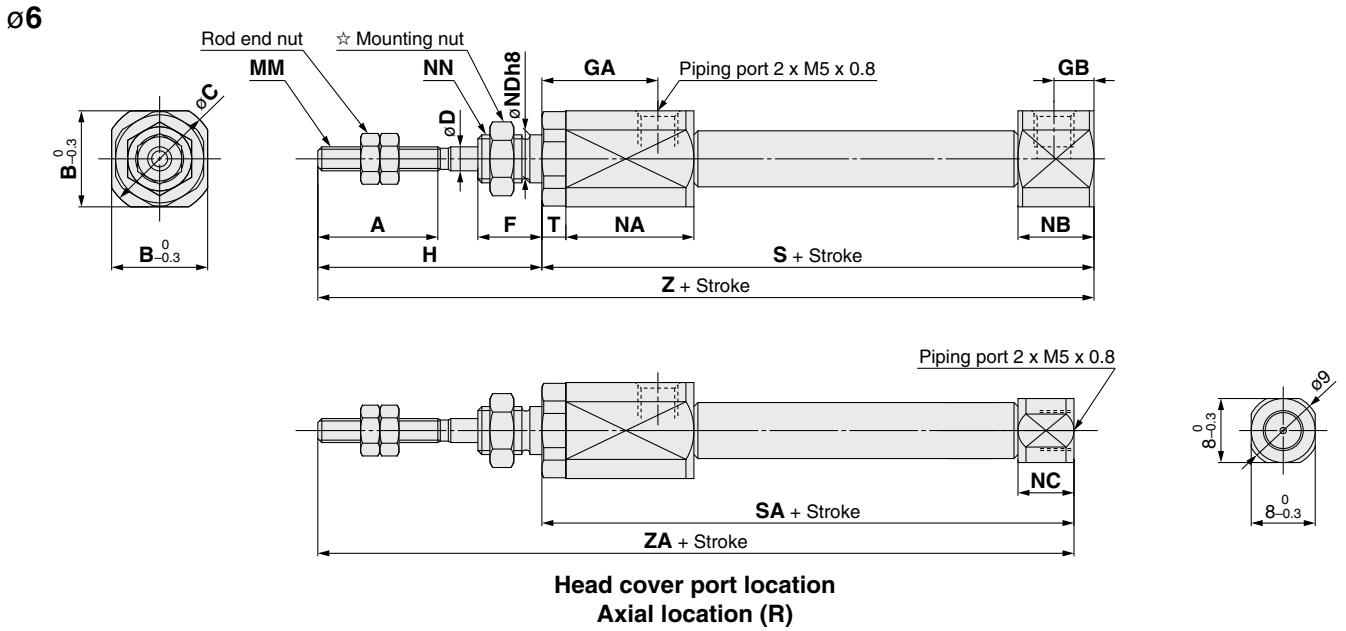

∅10, ∅16

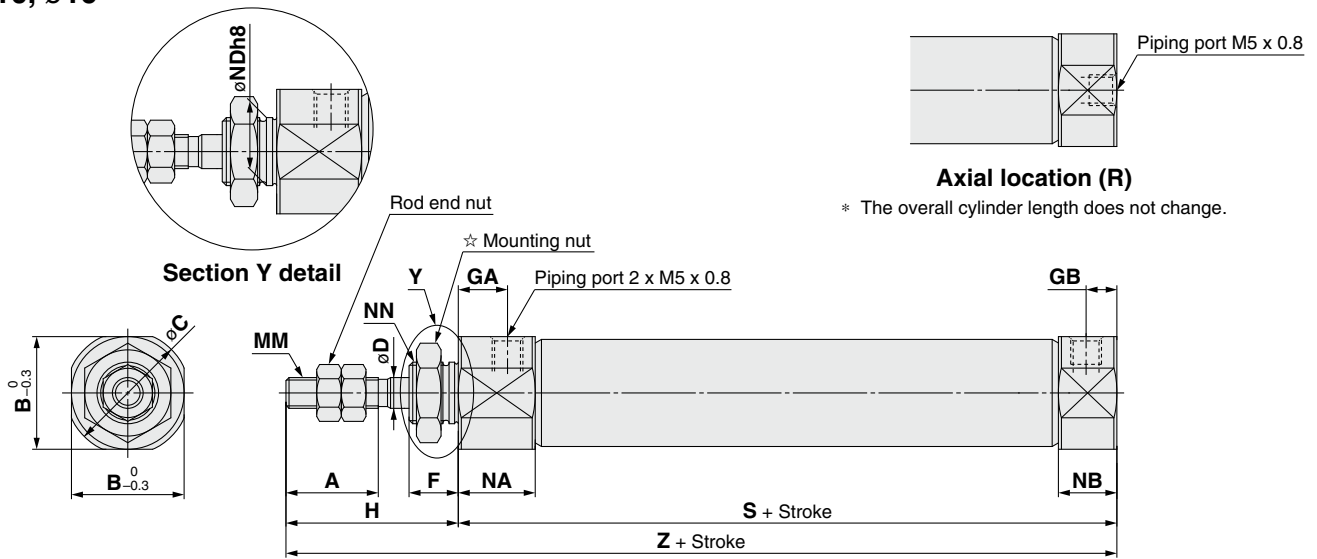

☆ For details of the mounting nut, refer to the **Web Catalog**.

Bore size	A	B	C	D	F	GA	GB	H	MM	NA	NB	NC	NDh8	NN	S	SA	T	Z	ZA
6	15	12	14	3	8	14.5	5	28	M3 x 0.5	16	9.5	7	6 ⁰ _{-0.018}	M6 x 1.0	51.5	49	3	79.5	77
10	15	12	14	4	8	8	5	28	M4 x 0.7	12.5	9.5	—	8 ⁰ _{-0.022}	M8 x 1.0	46	—	—	74	—
16	15	18.3	20	5	8	8	5	28	M5 x 0.8	12.5	9.5	—	10 ⁰ _{-0.022}	M10 x 1.0	47	—	—	75	—

Dimensions

Single foot bracket (L)

ø6

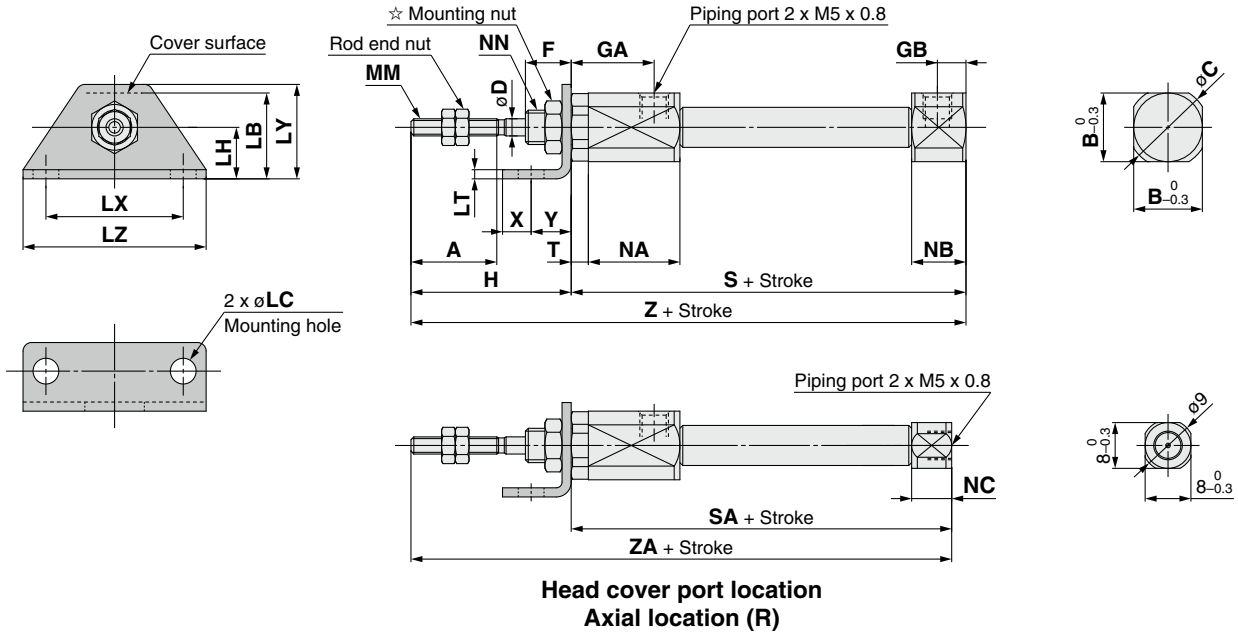

ø10, ø16

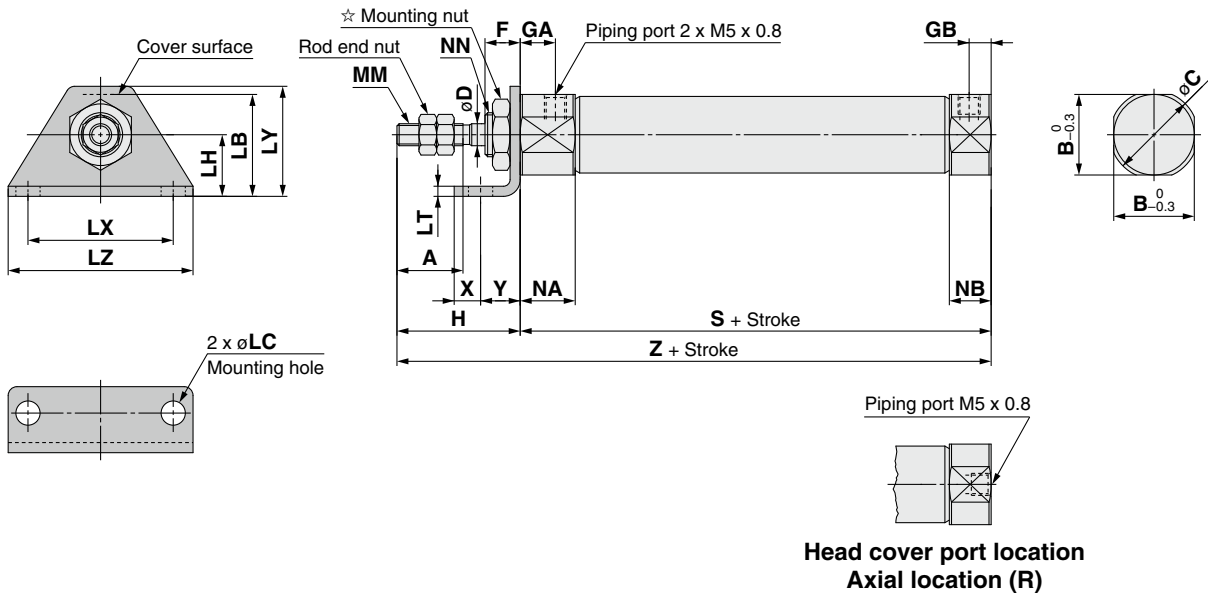

* The overall cylinder length does not change.

☆ For details of the mounting nut, refer to the [Web Catalog](#).

Bore size	A	B	C	D	F	GA	GB	H	LB	LC	LH	LT	LX	LY	LZ	MM	NA	NB	NC	NN	S	SA	T	X	Y	Z	ZA
6	15	12	14	3	8	14.5	5	28	15	4.5	9	1.6	24	16.5	32	M3 x 0.5	16	9.5	7	M6 x 1.0	51.5	49	3	5	7	79.5	77
10	15	12	14	4	8	8	5	28	15	4.5	9	1.6	24	16.5	32	M4 x 0.7	12.5	9.5	—	M8 x 1.0	46	—	—	5	7	74	—
16	15	18.3	20	5	8	8	5	28	23	5.5	14	2.3	33	25	42	M5 x 0.8	12.5	9.5	—	M10 x 1.0	47	—	—	6	9	75	—

[mm]

Dimensions

Double foot bracket (M)

ø6

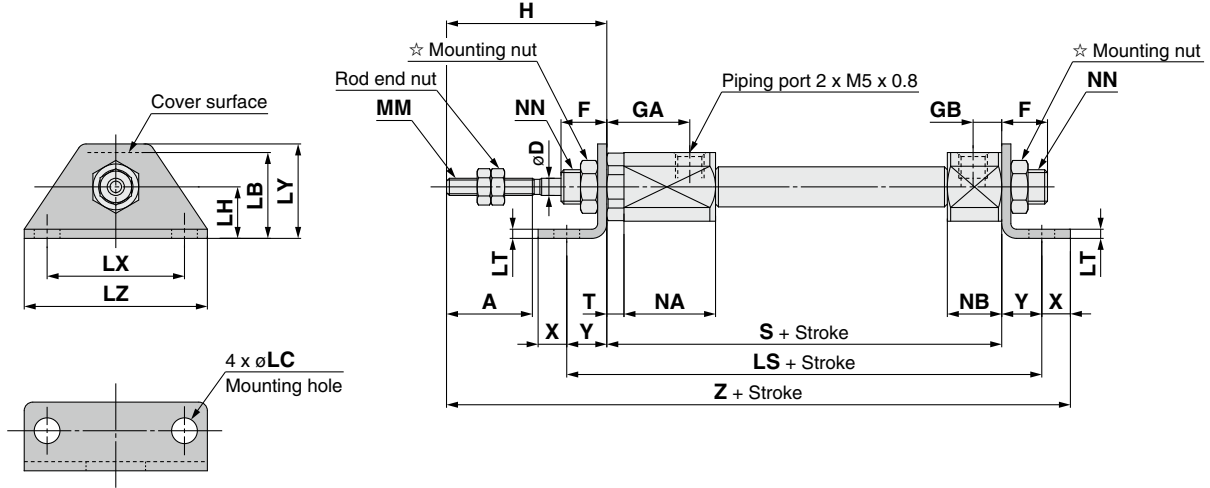

ø10, ø16

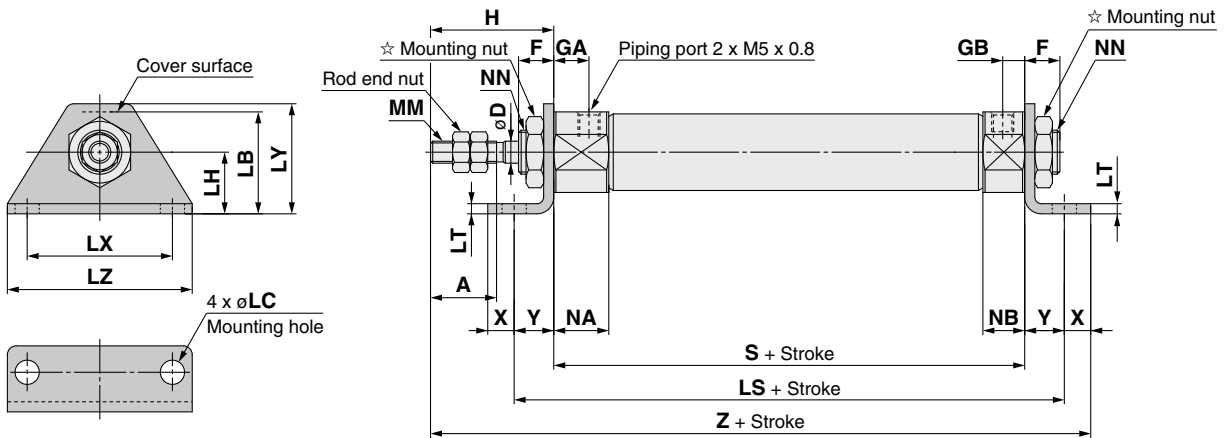

☆ For details of the mounting nut, refer to the [Web Catalog](#).

Bore size	A	D	F	GA	GB	H	LB	LC	LH	LS	LT	LX	LY	LZ	MM	NA	NB	NN	S	T	X	Y	Z
6	15	3	8	14.5	5	28	15	4.5	9	65.5	1.6	24	16.5	32	M3 x 0.5	16	9.5	M6 x 1.0	51.5	3	5	7	91.5
10	15	4	8	8	5	28	15	4.5	9	60	1.6	24	16.5	32	M4 x 0.7	12.5	9.5	M8 x 1.0	46	—	5	7	86
16	15	5	8	8	5	28	23	5.5	14	65	2.3	33	25	42	M5 x 0.8	12.5	9.5	M10 x 1.0	47	—	6	9	90

Dimensions

Rod flange (F)

ø6

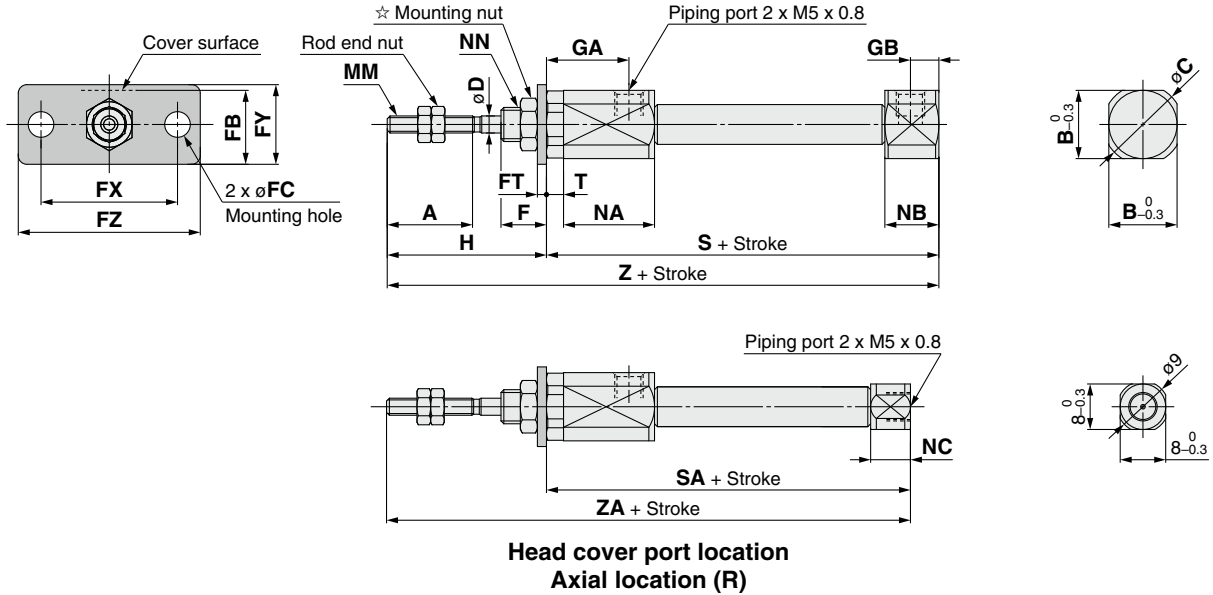

ø10, ø16

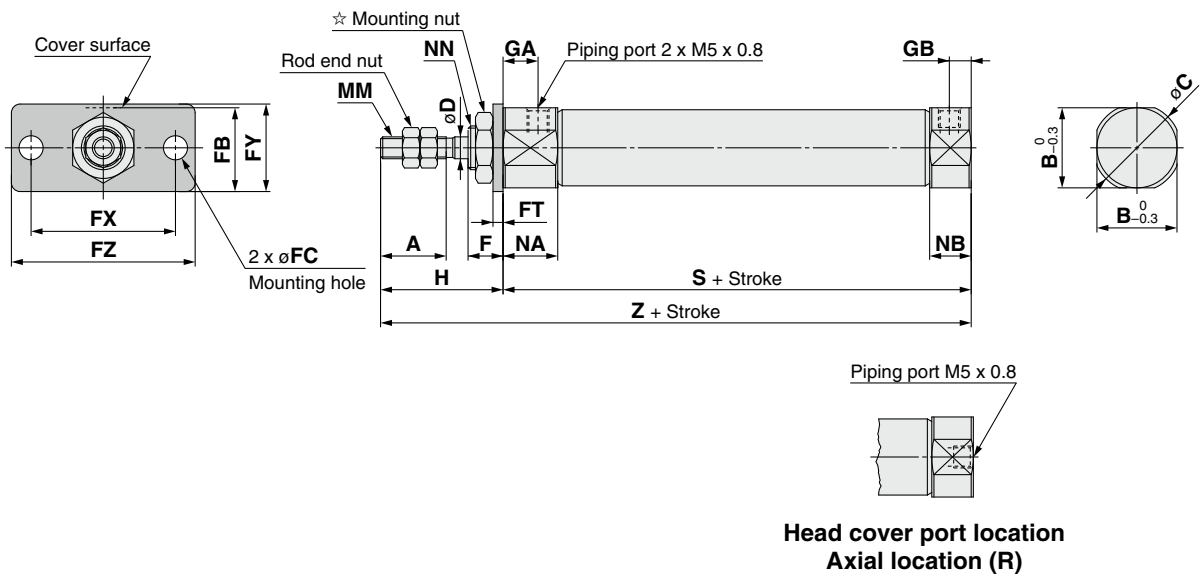

* The overall cylinder length does not change.

☆ For details of the mounting nut, refer to the [Web Catalog](#).

Bore size	A	B	C	D	F	FB	FC	FT	FX	FY	FZ	GA	GB	H	MM	NA	NB	NC	NN	S	SA	T	Z	ZA
6	15	12	14	3	8	13	4.5	1.6	24	14	32	14.5	5	28	M3 x 0.5	16	9.5	7	M6 x 1.0	51.5	49	3	79.5	77
10	15	12	14	4	8	13	4.5	1.6	24	14	32	8	5	28	M4 x 0.7	12.5	9.5	—	M8 x 1.0	46	—	—	74	—
16	15	18.3	20	5	8	19	5.5	2.3	33	20	42	8	5	28	M5 x 0.8	12.5	9.5	—	M10 x 1.0	47	—	—	75	—

Dimensions

Head flange (G)

ø6

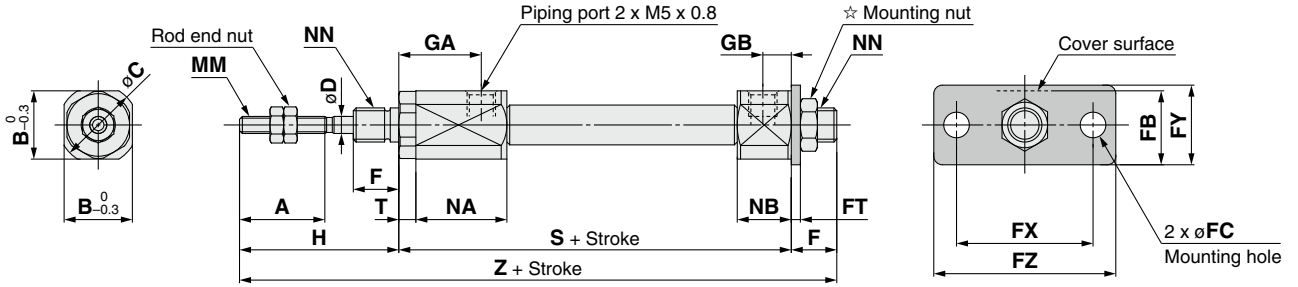

ø10, ø16

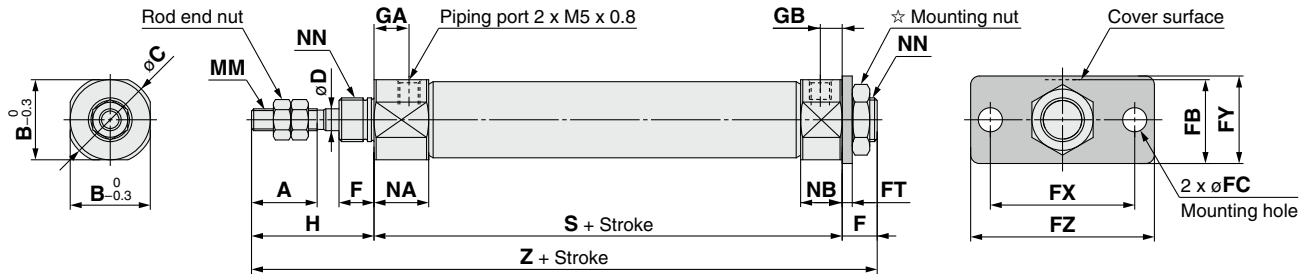

☆ For details of the mounting nut, refer to the **Web Catalog**.

Bore size	A	B	C	D	F	FB	FC	FT	FX	FY	FZ	GA	GB	H	MM	NA	NB	NN	S	T	Z
6	15	12	14	3	8	13	4.5	1.6	24	14	32	14.5	5	28	M3 x 0.5	16	9.5	M6 x 1.0	51.5	3	87.5
10	15	12	14	4	8	13	4.5	1.6	24	14	32	8	5	28	M4 x 0.7	12.5	9.5	M8 x 1.0	46	—	82
16	15	18.3	20	5	8	19	5.5	2.3	33	20	42	8	5	28	M5 x 0.8	12.5	9.5	M10 x 1.0	47	—	83

Dimensions

Double clevis (D)

ø10, ø16

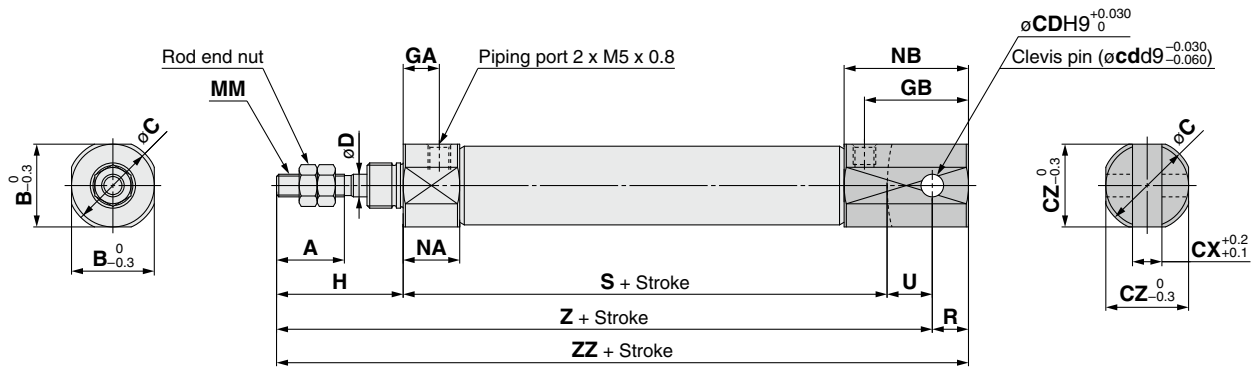

* A clevis pin and retaining rings are included.

Bore size	A	B	C	CD (cd)	CX	CZ	D	GA	GB	H	MM	NA	NB	R	S	U	Z	ZZ
10	15	12	14	3.3	3.2	12	4	8	18	28	M4 x 0.7	12.5	22.5	5	46	8	82	87
16	15	18.3	20	5	6.5	18.3	5	8	23	28	M5 x 0.8	12.5	27.5	8	47	10	85	93

[mm]

Dimensions

Double-side bossed (E)

ø6

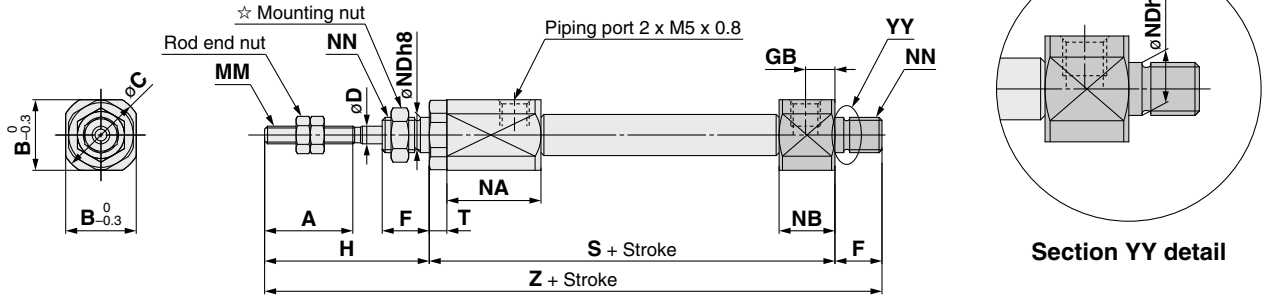

ø10, ø16

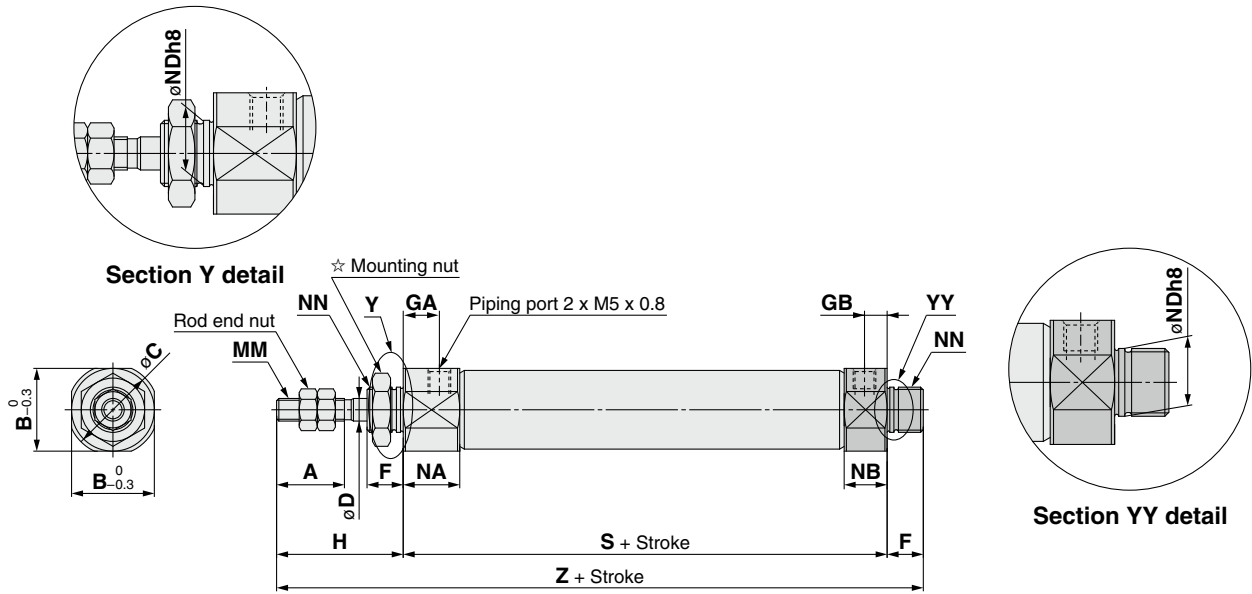

☆ For details of the mounting nut, refer to the **Web Catalog**.

Bore size	A	B	C	D	F	GA	GB	H	MM	NA	NB	NDh8	NN	S	T	Z
6	15	12	14	3	8	14.5	5	28	M3 x 0.5	16	9.5	6 ⁰ _{-0.018}	M6 x 1.0	51.5	3	87.5
10	15	12	14	4	8	8	5	28	M4 x 0.7	12.5	9.5	8 ⁰ _{-0.022}	M8 x 1.0	46	—	82
16	15	18.3	20	5	8	8	5	28	M5 x 0.8	12.5	9.5	10 ⁰ _{-0.022}	M10 x 1.0	47	—	83



Specific Product Precautions

Be sure to read this before handling the products. Refer to the back cover for safety instructions. For actuator and auto switch precautions, refer to the "Handling Precautions for SMC Products," the "Operation Manual," and air cylinder CJ2 series specific product precautions on the SMC website: <https://www.smcworld.com>

Handling

Warning

1. Use within the specified cylinder speed and kinetic energy ranges.

Otherwise, cylinder and seal damage may occur.

2. Do not apply excessive lateral load to the piston rod.

Easy checking method

Min. operating pressure after the cylinder is mounted to the equipment (MPa) = Min. operating pressure of cylinder (MPa) + {Load mass (kg) x Friction coefficient of guide/Sectional area of cylinder (mm²)}

If smooth operation is confirmed within the above value, the load on the cylinder is the resistance of the thrust only and it can be judged as having no lateral load.

3. Do not apply any torque to the cover joint.

Both the rod cover and head cover have wrench flats. When mounting the product, be sure to tighten with an appropriate amount of force.

When mounting the cylinder or installing a fitting to the port, perform tightening while holding the cover on the same side as the component being installed with a wrench.

Do not hold the cover on the opposite side. Failure to follow this instruction may cause the cover and tube joint to be broken by torque.

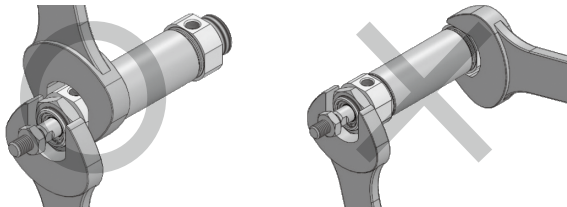

Caution

1. Tighten retaining screws to an appropriate tightening torque within the range given below.

ø6: 2.1 to 2.5 N·m, ø10: 5.9 to 6.4 N·m

ø16: 10.8 to 11.8 N·m

2. To remove and install retaining rings for knuckle pins or clevis pins, use an appropriate pair of pliers (tool for installing a type C retaining ring). In particular, use a pair of ultramini pliers for removing and installing retaining rings on the ø10 cylinder.

3. For the auto switch rail mounting type, do not remove the rail that is mounted.

Because retaining screws extend into the cylinder, this could lead to an air leak.

4. Please contact SMC when the stroke exceeds 100 mm for the axial foot mounting type.

Durability of The Cylinder

The durability of a longer life cylinder has been evaluated by comparison with the existing cylinders under SMC's test conditions.

The durability of a cylinder depends on the customer's operating conditions and operating environment.

Therefore, durability of four times or longer will not be guaranteed under all conditions.

Safety Instructions

These safety instructions are intended to prevent hazardous situations and/or equipment damage. These instructions indicate the level of potential hazard with the labels of “**Caution**,” “**Warning**” or “**Danger**.” They are all important notes for safety and must be followed in addition to International Standards (ISO/IEC)*1), and other safety regulations.

 **Caution:** **Caution** indicates a hazard with a low level of risk which, if not avoided, could result in minor or moderate injury.

 **Warning:** **Warning** indicates a hazard with a medium level of risk which, if not avoided, could result in death or serious injury.

 **Danger :** **Danger** indicates a hazard with a high level of risk which, if not avoided, will result in death or serious injury.

*1) ISO 4414: Pneumatic fluid power – General rules relating to systems.
ISO 4413: Hydraulic fluid power – General rules relating to systems.
IEC 60204-1: Safety of machinery – Electrical equipment of machines.
(Part 1: General requirements)
ISO 10218-1: Manipulating industrial robots – Safety.
etc.

Warning

1. The compatibility of the product is the responsibility of the person who designs the equipment or decides its specifications.

Since the product specified here is used under various operating conditions, its compatibility with specific equipment must be decided by the person who designs the equipment or decides its specifications based on necessary analysis and test results. The expected performance and safety assurance of the equipment will be the responsibility of the person who has determined its compatibility with the product. This person should also continuously review all specifications of the product referring to its latest catalog information, with a view to giving due consideration to any possibility of equipment failure when configuring the equipment.

2. Only personnel with appropriate training should operate machinery and equipment.

The product specified here may become unsafe if handled incorrectly. The assembly, operation and maintenance of machines or equipment including our products must be performed by an operator who is appropriately trained and experienced.

3. Do not service or attempt to remove product and machinery/equipment until safety is confirmed.

1. The inspection and maintenance of machinery/equipment should only be performed after measures to prevent falling or runaway of the driven objects have been confirmed.
2. When the product is to be removed, confirm that the safety measures as mentioned above are implemented and the power from any appropriate source is cut, and read and understand the specific product precautions of all relevant products carefully.
3. Before machinery/equipment is restarted, take measures to prevent unexpected operation and malfunction.

4. Contact SMC beforehand and take special consideration of safety measures if the product is to be used in any of the following conditions.

1. Conditions and environments outside of the given specifications, or use outdoors or in a place exposed to direct sunlight.
2. Installation on equipment in conjunction with atomic energy, railways, air navigation, space, shipping, vehicles, military, medical treatment, combustion and recreation, or equipment in contact with food and beverages, emergency stop circuits, clutch and brake circuits in press applications, safety equipment or other applications unsuitable for the standard specifications described in the product catalog.
3. An application which could have negative effects on people, property, or animals requiring special safety analysis.
4. Use in an interlock circuit, which requires the provision of double interlock for possible failure by using a mechanical protective function, and periodical checks to confirm proper operation.

Caution

1. The product is provided for use in manufacturing industries.

The product herein described is basically provided for peaceful use in manufacturing industries.
If considering using the product in other industries, consult SMC beforehand and exchange specifications or a contract if necessary.
If anything is unclear, contact your nearest sales branch.

Limited warranty and Disclaimer/ Compliance Requirements

The product used is subject to the following “Limited warranty and Disclaimer” and “Compliance Requirements”.

Read and accept them before using the product.

Limited warranty and Disclaimer

1. The warranty period of the product is 1 year in service or 1.5 years after the product is delivered, whichever is first.*2)
Also, the product may have specified durability, running distance or replacement parts. Please consult your nearest sales branch.
2. For any failure or damage reported within the warranty period which is clearly our responsibility, a replacement product or necessary parts will be provided.
This limited warranty applies only to our product independently, and not to any other damage incurred due to the failure of the product.
3. Prior to using SMC products, please read and understand the warranty terms and disclaimers noted in the specified catalog for the particular products.

*2) Vacuum pads are excluded from this 1 year warranty.

A vacuum pad is a consumable part, so it is warranted for a year after it is delivered.
Also, even within the warranty period, the wear of a product due to the use of the vacuum pad or failure due to the deterioration of rubber material are not covered by the limited warranty.

Compliance Requirements

1. The use of SMC products with production equipment for the manufacture of weapons of mass destruction (WMD) or any other weapon is strictly prohibited.
2. The exports of SMC products or technology from one country to another are governed by the relevant security laws and regulations of the countries involved in the transaction. Prior to the shipment of a SMC product to another country, assure that all local rules governing that export are known and followed.

Caution

SMC products are not intended for use as instruments for legal metrology.

Measurement instruments that SMC manufactures or sells have not been qualified by type approval tests relevant to the metrology (measurement) laws of each country. Therefore, SMC products cannot be used for business or certification ordained by the metrology (measurement) laws of each country.

Safety Instructions

Be sure to read the “Handling Precautions for SMC Products” (M-E03-3) and “Operation Manual” before use.

SMC Corporation

Akihabara UDX 15F,
4-14-1, Sotokanda, Chiyoda-ku, Tokyo 101-0021, JAPAN
Phone: 03-5207-8249 Fax: 03-5298-5362
<https://www.smcworld.com>
© 2023 SMC Corporation All Rights Reserved

Specifications are subject to change without prior notice
and any obligation on the part of the manufacturer.

D-G